

English version

ARC·SYSTEM

Lighting Imagination



MAXPOWER

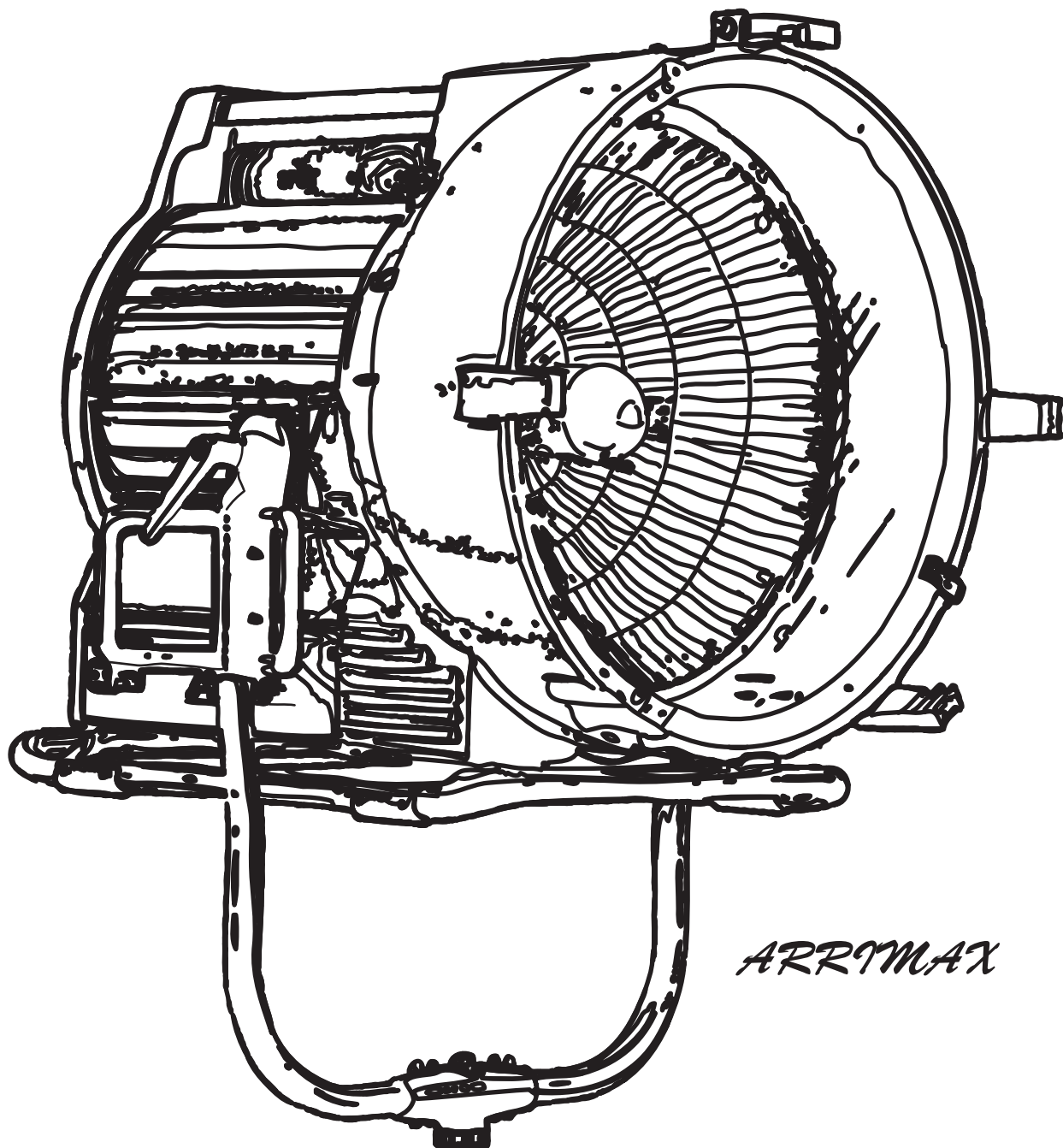

ARRIMAX

We provide full support for your lighting work.

ARC·SYSTEM

UNLIMITED CREATIVITY

~For safety use of lighting equipment.~

Would you please read "Precautions for safety use." in TECHNICAL DATA before use. Lighting equipments are used in high volatage cuurrent, and generate high heat and ultraviolet rays. If you use inappropriately, it could lead to a big accident.



BRIESELIGHT

※ Rental Fee doesn't include tax.

- TRUCK LINEUPP3
- DAYLIGHTP4
- STROBE.....P24
- TUNGSTENP28
- KINOFLOP46
- LED.....P53
- BATTERYP60
- OTHER EQUIPMENTS.....P61
- STAND.....P66
- GRIPP69
- GENERATOR / VARIACP78
- OTHER EQUIPMENTS.....P80
- FRAMEP84
- CLOTH.....P88
- TECHNICAL DATAP93
- FLICKER DATA.....P94
- ATTENTIONP95
- BATTERY GUIDEP97

SOCKET

- AD100A
- C60A
- C30A
- 2P

DIMENSION

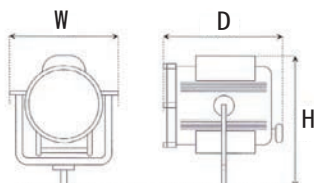

About Exposure Data (ISO200 30FPS)
 This data is the average of two lights measured by incident exposure meter. We recommend to use this data only for the reference.

CONTENTS

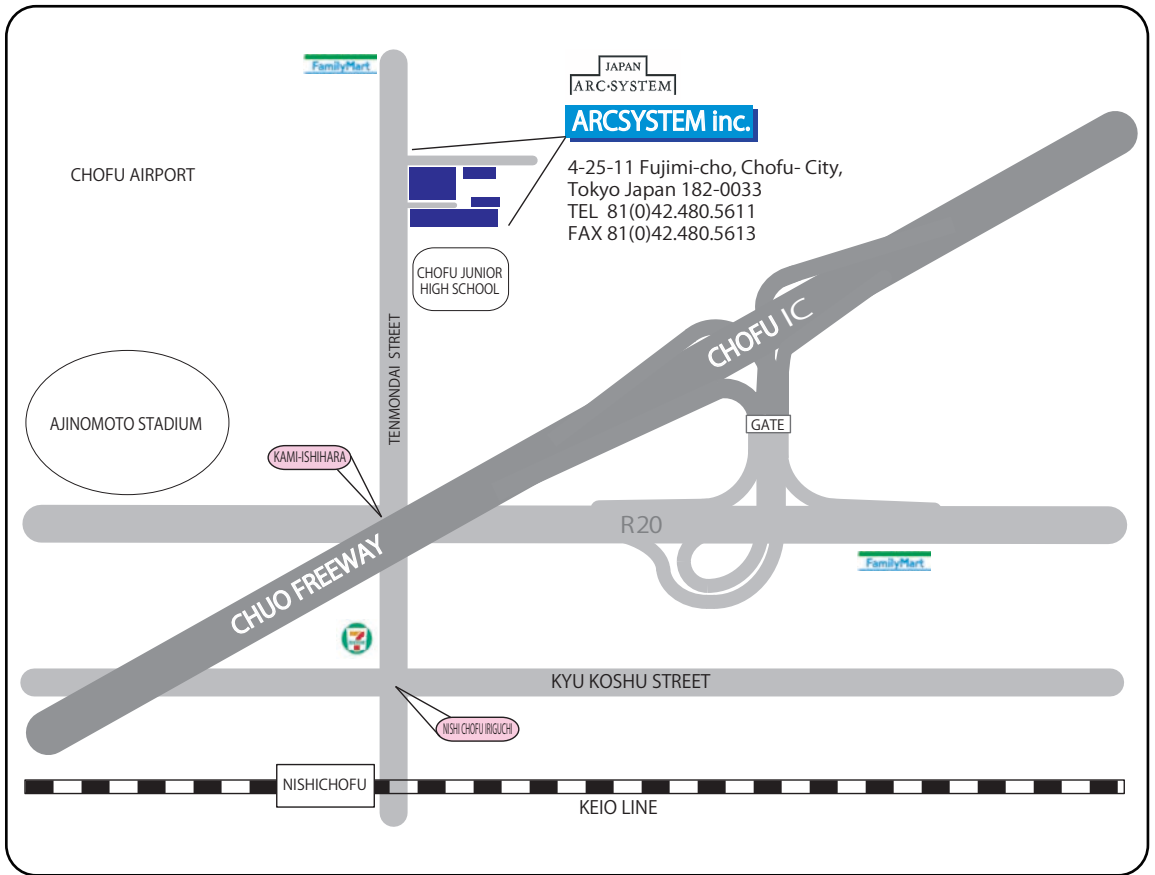

Kansai Office

ARC·SYSTEM Kansai Office
 2-9-18, Hoshin, Higashi Yodogawa-ku,
 Osaka Japan 533-0014
 TEL 06-6370-6811 FAX 06-6370-6813

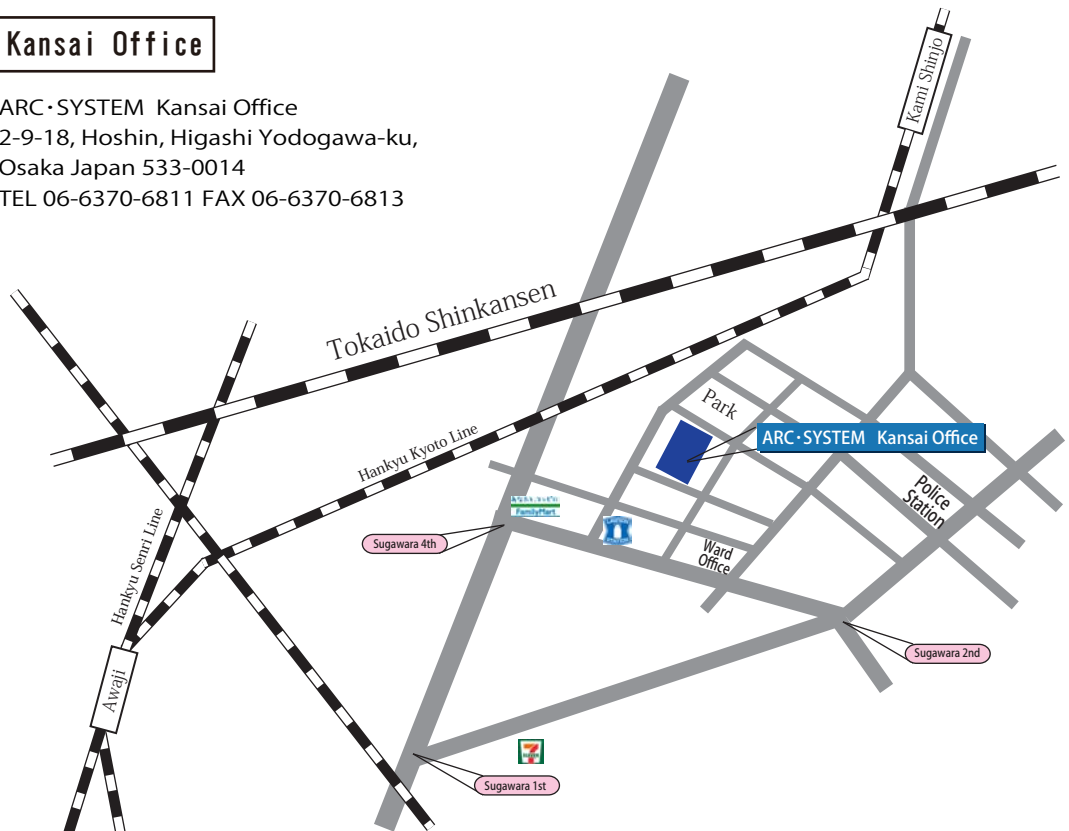



2 t TRUCK SHORT

3 t LOW ROOF TRUCK

4 t TRUCK

Name	Overall Width	Overall Length	Overall Height	Talegate Width	Container Inside Length	Container Inside Height	Side Door Width	Side Door Height
4t TRUCK	2.34	7.89	3.39	2.17	5.7	2.29	0.9	2.05
3t HIGH ROOF TRUCK	2.20	6.98	3.35	2.05	5	2.25	0.86	1.83
3t LOW ROOF TRUCK	2.21	7.06	3.14	2.05	5	2.25	0.86	1.83
2t TRUCK SHORT	1.89	5.49	2.94	1.81	3.74	2	0.88	1.79
VAN ※	1.69	4.99	1.99	1.32	3	1.3	1.1	1.44

measured in meters

- 4t TRUCK Carrying Capacity 12Cargos + F case
- 3t LOW ROOF·HIGH ROOF TRUCK Carrying Capacity ... 10Cargos + F case
- 2t TRUCK SHORT Carrying Capacity 6Cargos + F case

Cargo Size

Brown Cargo	1,000mm (W) × 1,700mm (H) × 805mm (D)
Brown Cargo Half	1,000mm (W) × 1,100mm (H) × 805mm (D)
Pink Cargo	900mm (W) × 1,700mm (H) × 700mm (D)
Green Cargo	850mm (W) × 1,700mm (H) × 650mm (D)



※ Rental Fee doesn't include tax.

Precautions for use of lighting equipment

Hold a plug when unplug. Otherwise it may cause the damage of cables or other parts. Keep flammable materials away from fixtures because fixtures will be very hot during lighting and right after turn-off. Otherwise may cause fire or burn.

★Precautions for use of HMI★

Before turning off HMI, please keep HMI turned on 10minutes at full Dimmer volume of Ballast. If you turn off HMI without this procedure, color temperature will be lower considerably. ※ Because HMI need very long time to recover the normal color temperature.

※When using Ballast, please keep each Ballast away to avoid overheat.

AD100A



300Hz
12000/18000EB. . Pmax 19. 4KVA
Dimension
360mm (W) × 785mm (H) × 510mm (D)
Weight 50kg

AD100A



300Hz
12000/18000EB. . Pmax 19. 4KVA
Dimension
305mm (W) × 730mm (H) × 525mm (D)
Weight 49kg

AD100A



300Hz
6000/12000EB
Pmax 6. 9KVA (6000W)
Pmax 13. 2KVA (12000W)
Dimension 260mm (W) × 675mm (H) × 510mm (D)
Weight 50.5kg

C30A



300Hz
1200/1800EB. . Pmax 2600VA
Dimension
200mm (W) × 170mm (H) × 360mm (D)
Weight 8kg

2P



300Hz
575/1200EB. . Pmax 1390VA
Dimension
200mm (W) × 170mm (H) × 340mm (D)
Weight 8kg

2P



300Hz
575/800EB. . Pmax 1100VA
Dimension
200mm (W) × 140mm (H) × 335mm (D)
Weight 6.5kg

C60A



300Hz
2500/4000EB. . Pmax 4650VA
Dimension
250mm (W) × 300mm (H) × 450mm (D)
Weight 24kg

2P

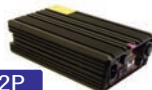

300Hz
125/200EB. Pmax 225VA
Dimension
130mm (W) × 67mm (H) × 237mm (D)
Weight 2kg

2P



200EB. Pmax 320VA
Dimension
145mm (W) × 135mm (H) × 210mm (D)
Weight 3kg

BURN TIME

HMI 18kwARRIMAX.....	¥ 6,000	HMI 4kw.....	¥ 2,000
HMI 18kw.....	¥ 5,000	HMI 2.5kw.....	¥ 1,500
HMI 12kw/9kwARRIMAX...	¥ 4,000	HMI 1.8kw.....	¥ 1,300
HMI 6kw.....	¥ 2,500	HMI 1.2kw.....	¥ 1,200

※Above Burn time fee is charged per hour.
※We calculate Burn time fee for 8 hours a day for estimate. * No Burn time fee is charged for the light under 1.2kw.
※ Burn Time doesn't include tax.

★Warning for use of HMI★

Do not use at the unallowable angles because HMI fixtures generate high voltage and many electric parts are built-in. Use at unallowable angle could cause fixture damage, failure and bulb explosion. Ballast should be stored in safe place which does not receive the direct sunlight and also should avoid high temperature, humid vibration and impact shock. Incorrect use could cause fixture damage, failure and bulb explosion.

※ Rental Fee doesn't include tax.

ARRI 18kw MAME HMI

RENTAL FEE ¥70,000 (Excluding Burn time)

AD100A

max/up 90° /down 90°

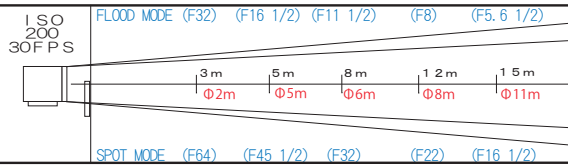

- Dimension 1160mm (W) × 1120mm (H) × 850mm (D) (except Barndoor)
- Weight 76kg ● Lens size 625mm ● Spigot 29φ
- Input power 200V ※This Light can be used 90° downward !!

※When use it downward, please use explosion-proof net.

ACCESSORIES

- Extension cable (20m) ¥2,500
- Scrim ¥2,500
- SL size Chimera Plus Bank ¥13,000
- Shutter ¥5,000

ARRI 18kw HMI

RENTAL FEE ¥70,000 (Excluding Burn time)

AD100A

max/up 60° /down 60°

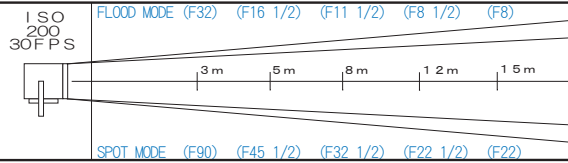

- Dimension 1160mm (W) × 1120mm (H) × 850mm (D) (except Barndoor)
- Weight 73kg ● Lens size 625mm ● Spigot 29φ
- Input power 200V

ACCESSORIES

- Extension cable (20m) ¥2,500
- Scrim ¥2,500
- SL size Chimera Plus Bank ¥13,000
- Shutter ¥5,000

ARRI 12kw HMI

RENTAL FEE ¥50,000 (Excluding Burn time)

AD100A

max/up 60° /down 60°

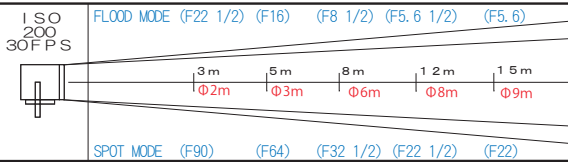

- Dimension 800mm (W) × 935mm (H) × 660mm (D) (except Barndoor)
- Weight 62kg ● Lens size 510mm ● Spigot 29φ
- Input power 200V

ACCESSORIES

- Extension Cable (20m) ¥2,000
- Scrim ¥2,000
- L size Chimera Plus Bank ¥11,000
- Shutter ¥3,000
- Snoot ¥8,000

ALFA 12/6kw HMI

12k ¥55,000 / 6k ¥35,000 (Excluding Burn time)

AD100A

max/up 60° /down 60°

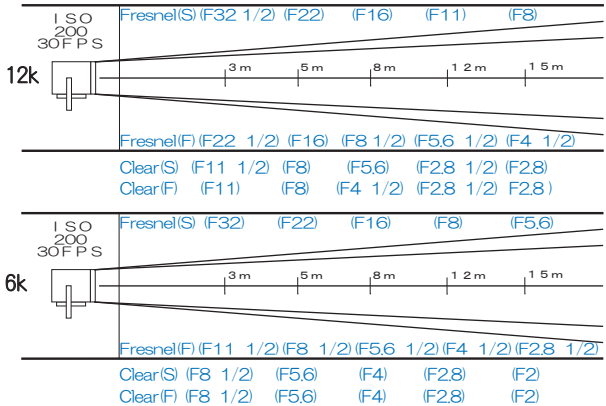

- Dimension 970mm (W) × 1200mm (H) × 500mm (D) (except Barndoor)
- Weight 60.5kg ● Lens size 600mm (Fresnel Lens 15kg / Clear Lens 8kg)
- Spigot 29φ ● Input power 200V

ACCESSORIES

※Scrims are not available for this Light.

※ Rental Fee doesn't include tax.

LTM18/12kw

RENTAL FEE 18k ¥70,000 / 12k ¥50,000 (Excluding Burn time) **AD100A**

max/up 60° /down 60°

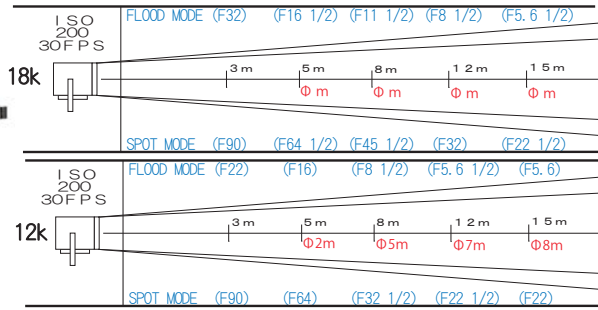

ACCESSORIES

- Dimension 860mm (W) × 1,170mm (H) × 735mm (D) (except Barndoor)
- Weight 65kg
- Lens size 630mm
- Spigot 29φ
- Input power 200V
- Scrim ¥2,500
- SL size Chimera Plus Bank ¥13,000

ARRI 12kw HMI CP

RENTAL FEE ¥50,000 (Excluding Burn time) **AD100A**

max/up 75° /down 75°

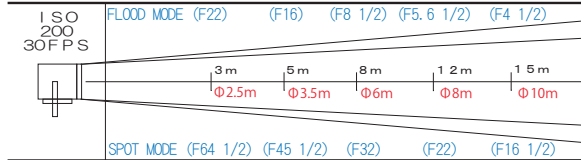

- Dimension 870mm (W) × 1,130mm (H) × 710mm (D) (except Barndoor)
- Weight 49kg ● Lens size 480mm ● Spigot 29φ
- Input power 200V

ACCESSORIES

- Extension Cable (20m) ¥2,000
- Scrim ¥2,000
- L size Chimera Plus Bank ¥11,000
- Shutter ¥3,000

LTM 12kw HMI CP

RENTAL FEE ¥50,000 (Excluding Burn time) **AD100A**

max/up 60° /down 60°

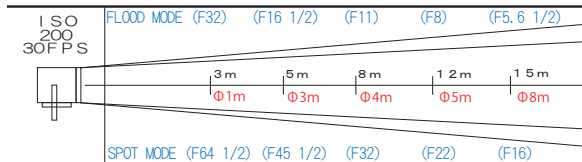

- Dimension 710mm (W) × 1,200mm (H) × 570mm (D) (except Barndoor)
- Weight 42kg ● Lens size 470mm ● Spigot 25φ
- Input power 200V

ACCESSORIES

- Extension Cable (20m) ¥2,000
- Scrim ¥2,000
- M size Chimera Plus Bank ¥11,000
- Shutter ¥3,000

ARRI 6kw HMI CP

RENTAL FEE ¥30,000 (Excluding burn time) **AD100A**

max/up 90° /down 90°

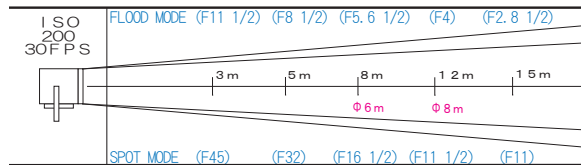

- Dimension 700mm (W) × 855mm (H) × 540mm (D) (except Barndoor)
- Weight 34kg ● lens Diameter 420mm ● Spigot 25φ
- Input power 100/200V (auto sensing)

※When use it downward, please use explosion-proof net.

ACCESSORIES

- Extension cable (20m) ¥2,000
- Scrim ¥2,000
- M size Chimera Plus Bank ¥11,000
- Shutter ¥3,000
- Snoot ¥5,000
- Bag-O-Light ¥30,000

ARRI TRUE BLUE D40

RENTAL FEE ¥20,000 (Excluding burn time) **C60A**

max/up 90° /down 90°

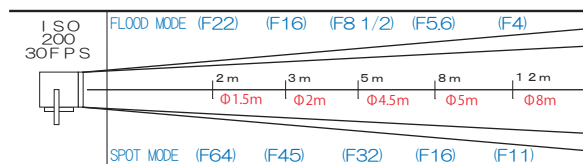

- Dimension 534mm (W) × 859mm (H) × 403mm (D) (except Barndoor)
- Weight 18kg ● lens Diameter 300mm ● Spigot 25φ
- Input power 100/200V (auto sensing)

※When use it downward, please use explosion-proof net.

ACCESSORIES

- Extension cable (8m) ¥1,500
- Scrim ¥1,500
- M size Chimera Plus Bank ¥1,000
- Shutter ¥2,000
- Snoot ¥5,000
- Bag-O-Light ¥30,000
- CUBE SILK Attachment 4kwTB/CP/ARRIX4kw ¥500

※ Rental Fee doesn't include tax.

ARRI 4kw HMI CP

RENTAL FEE ¥20,000
(Excluding burn time)

C60A max/up 90° /down 60°

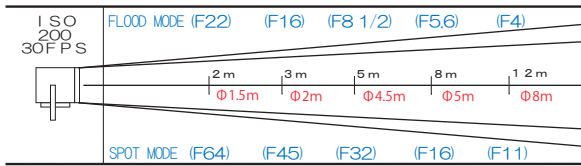

- Dimension 640mm (W) × 650mm (H) × 490mm (D) (except Barrndor)
- Weight 23kg ● lens Diameter 300mm ● Spigot 25φ
- Input power 100/200V(auto sensing)

※ Do not use this more than 60° downside

ACCESSORIES

- Extension cable (8m) ¥1,500
- Scrim ¥1,500
- M size Chimera Plus Bank ¥11,000
- Shutter ¥2,000
- Snoot ¥5,000
- Bag-O-light ¥30,000
- CUBE SILK Attachment 4kwTB/CP/ARRIX4kw ¥500

ALFA 4kw HMI

RENTAL FEE ¥20,000
(Excluding burn time)

C60A max/up 90° /down 90°

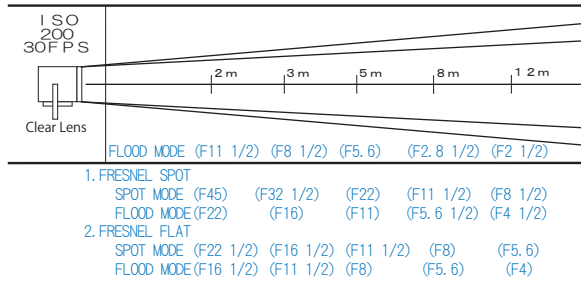

- Dimension 550mm (W) × 840mm (H) × 340mm (D) (except Barrndor)
- Weight 21kg
- Lens Diameter 340mm
- Spigot 25φ
- Input Power 100/200V (auto sensing)

ACCESSORIES

- Extension cable (8m) ¥1,500
- SPACE BEAM(attached)
- Dimension 550mm (W) × 840mm (H) × 340mm (D) (except Barrndor)
- Weight 21kg
- Lens Diameter 340mm
- Spigot 25φ
- Input Power 100/200V (auto sensing)

ARRI TRUE BLUE D25

RENTAL FEE ¥18,000
(Excluding burn time)

C60A max/up 90° /down 90°

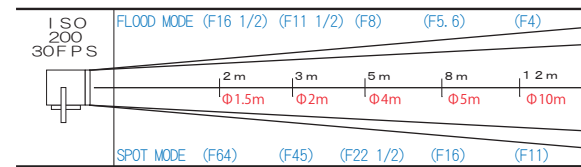

- Dimension 450mm (W) × 770mm (H) × 410mm (D) (except Barrndor)
- Weight 15kg ● Lens Diameter 250mm ● Spigot 25φ
- Input Power 100/200V(auto sensing)

※When use it downward, please use explosion-proof net.

ACCESSORIES

- Extension cable(8m) ¥1,500
- Scrim ¥1,500
- S size Chimera Plus Bank ¥7,000
- Shutter ¥2,000
- Snoot ¥3,000
- ELLI Lens ¥5,000
- CUBE SILK Attachment 2.5kwTB/CP/ARRIX2.5kw ¥500

ARRI 2.5kw HMI CP

RENTAL FEE ¥18,000
(Excluding burn time)

C60A max/up 90° /down 60°

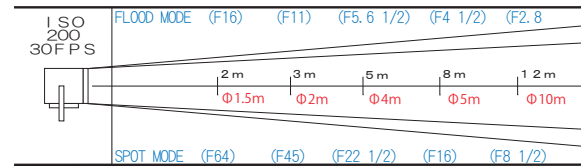

- Dimension 540mm (W) × 560mm (H) × 390mm (D) (except Barrndor)
- Weight 19kg ● Lens Diameter 250mm ● Spigot 25φ
- Input power 100/200V (auto sensing)

※ Do not use this more than 60° downside

ACCESSORIES

- Extension cable(8m) ¥1,500
- Scrim ¥1,500
- S size Chimera Plus Bank ¥7,000
- Shutter ¥2,000
- Snoot ¥3,000
- ELLI Lens ¥5,000
- CUBE SILK Attachment 2.5kwTB/CP/ARRIX2.5kw ¥500

ARRI TRUE BLUE D12

RENTAL FEE ¥10,000
(Excluding burn time)

2P max/up 90° /down 90°

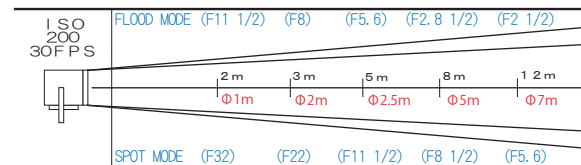

- Dimension 350mm (W) × 660mm (H) × 300mm (D) (except Barrndor)
- Weight 9.9kg ● Lens Diameter 175mm ● Spigot 17φ
- Input Power 100/200V(auto sensing)

※When use it downward, please use explosion-proof net.

ACCESSORIES

- Extension cable (8m) ¥1,000
- Scrim ¥1,000
- S size Chimera Plus Bank ¥7,000
- Shutter ¥1,000
- Snoot ¥2,000
- ELLI Lens ¥5,000

※ Rental Fee doesn't include tax.

ARRI 1.2kw HMI CP

RENTAL FEE ¥ 10,000
(Excluding burn time)

2P

max/up 90° /down 60°

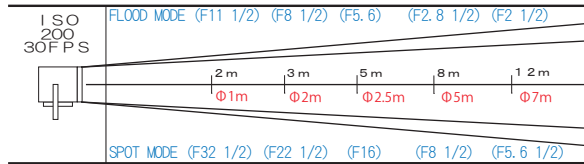

- Dimension 380mm (W) × 460mm (H) × 380mm (D) (except Barndoor)
- Weight 10kg ● Lens Diameter 175mm ● Spigot 17φ
- Input Power 100/200V(auto sensing)

※ Do not use this more than 60° downside

ACCESSORIES

- Extension cable (8m) ¥1,000
- Scrim ¥1,000
- S size Chimera Plus Bank ¥7,000
- Shutter ¥1,000
- Snoot ¥2,000
- ELLI Lens ¥5,000

RDS 575w UNI

RENTAL FEE ¥ 7,000

2P

max/up 90° /down 90°

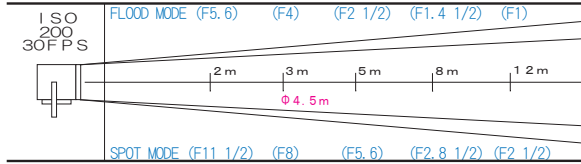

- Dimension 235mm (W) × 260mm (H) × 215mm (D) (except Barndoor)
- Weight 4kg ● Lens Diameter 140mm ● Spigot 17φ
- Input power 100/200V (auto sensing)

※When use it downward, please use explosion-proof net.

ACCESSORIES

- Extension cable (8m) ¥1,000
- XS size Chimera Plus Bank ¥5,000
- Chimera Lantern ¥3,000

ARRI 575w HMI CP

RENTAL FEE ¥ 10,000

2P

max/up 90° /down 60°

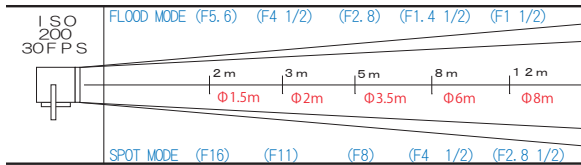

- Dimension 330mm (W) × 385mm (H) × 290mm (D) (except Barndoor)
- Weight 7kg ● Lens Diameter 130mm ● Spigot 17φ
- Input power 100/200V (auto sensing)

※When use it downward, please use explosion-proof net.

ACCESSORIES

- Extension cable (8m) ¥1,000
- Scrim ¥1,000
- XS size Chimera Plus Bank ¥5,000
- Shutter ¥1,000
- Snoot ¥2,000
- ELLI Lens ¥5,000

ARRI TRUE BLUE D5

RENTAL FEE ¥ 10,000

2P

max/up 90° /down 90°

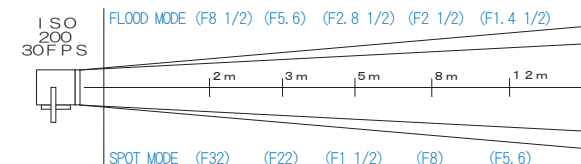

- Dimension 327mm (W) × 432mm (H) × 223mm (D) (except Barndoor)
- Weight 7.5kg ● Lens Diameter 150mm ● Spigot 17φ
- Input power 100/200V (auto sensing)

ACCESSORIES

- Extension cable (8m) ¥1,000
- Scrim ¥1,000
- S size Chimera Plus Bank ¥7,000
- Shutter ¥1,000
- Snoot ¥2,000
- ELLI Lens ¥5,000

BLACKJACK 400

max/up 90° /down 90°

2P

価格 ¥ 15,000 (税別)

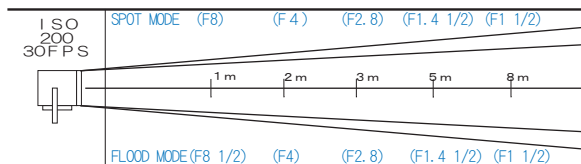

- 1: SPOT MODE
- 1: SPOT LENS (F45 1/2) (F22 1/2) (F16 1/2) (F11) (F5.6)
 - 2: FLOOD LENS (F22) (F11 1/2) (F8 1/2) (F5.6) (F2.8 1/2)
 - 1: SPOT LENS (F16) (F8) (F5.6) (F2.8 1/2) (F2)
 - 2: FLOOD LENS (F11 1/2) (F5.6 1/2) (F4) (F2 1/2) (F1.4 1/2)

- Dimension 270mm (W) × 175mm (H) × 260mm (D) (except Barndoor)
- Weight 3.18kg ● Lens Diameter 130mm ● Spigot 17φ
- Input power 100/200V (auto sensing)

ACCESSORY

- Spot&Flood Lens Includre
- D&T Light Bulb Includre

※ Rental Fee doesn't include tax.

ARRI 200w HMI CP

RENTAL FEE ¥ 10, 000

2P

max /up 90° /down 90°

ACCESSORIES

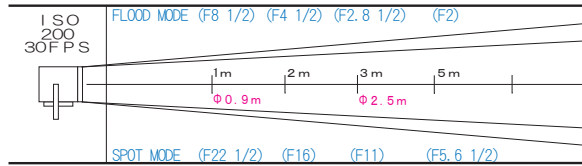

- Scrim ¥500
- XS size Chimera Plus Bank ¥5,000
- Shoot ¥1,000

- Dimension 220mm (W) × 300mm (H) × 220mm (D) (except Barrdoor)
- Weight 3kg ● Lens Diameter 112mm ● Spigot 17φ
- Input power 100/200V (auto sensing)

ARRI 125w HMI CP

RENTAL FEE ¥ 8, 000

2P

max /up 90° /down 90°

ACCESSORIES

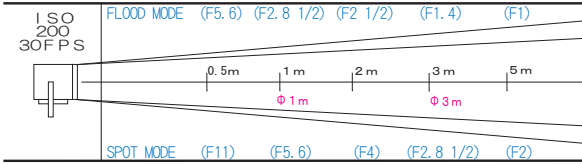

- Scrim ¥500
- XS size Chimera Plus Bank ¥5,000
- Shoot ¥1,000

- Dimension 205mm (W) × 260mm (H) × 185mm (D) (except Barrdoor)
- Weight 1.5kg ● Lens Diameter 80mm ● Spigot 17φ
- Input power 100/200V (auto sensing)



※ Rental Fee doesn't include tax.

BRIESE LIGHT HMI 6kw/4kw/2.5kw/1.2kw

※You can choose any bulbs (1.2k/2.5k/4k/6k) shown below at the same rental fee.
RENTAL FEE 6kw ¥36,000 / 575w~4kw ¥24,000



		Mode	2m	3m	5m	8m	12m	Spigot	Weight Stand (Remote Stand)	Rental Fee Stand (Remote Stand)	Memo
Focus330	6kw	Flood	F22	F16 1/2	F11	F5.6	F2.8 1/2	29Φ	20.6kg (26.2kg)	6kwHMI ¥129,000 (¥145,000)	Soft Egg Crate ¥21,000
		Spot	F22	F16 1/2	F16	F11	F8				
	4kw	Flood	F16 1/2	F16	F8 1/2	F4 1/2	F2.8				
		Spot	F16	F16	F11	F8	F5.6				
	2.5kw	Flood	F16	F11	F5.6 1/2	F4	F2 1/2				
		Spot	F11	F11	F8 1/2	F5.6 1/2	F4 1/2				
	1.2kw	Flood	F11	F8	F4 1/2	F2.8	F1.4 1/2				
		Spot	F8	F5.6 1/2	F5.6	F4	F2.8				
Focus220	4kw	Flood	F32 1/2	F16 1/2	F8 1/2	F4 1/2	F2.8	25Φ	14.8kg (20.4kg)	¥78,000 (¥94,000)	Soft Egg Crate ¥14,000
		Spot	F45	F32	F22	F16	F11				
	2.5kw	Flood	F32	F16	F8	F4	F2.8				
		Spot	F32	F22 1/2	F16 1/2	F11	F8				
	1.2kw	Flood	F16 1/2	F11	F5.6	F2.8	F1.4 1/2				
		Spot	F22	F16	F11	F8	F5.6				
Focus180	4kw	Flood	F32	F16 1/2	F8	F4 1/2	F2.8	25Φ	12.9kg (18.2kg)	¥76,000 (¥92,000)	Soft Egg Crate ¥12,000
		Spot	F45	F32 1/2	F22	F11 1/2	F8				
	2.5kw	Flood	F22	F11 1/2	F5.6 1/2	F4	F2 1/2				
		Spot	F32	F22	F16	F8 1/2	F5.6 1/2				
	1.2kw	Flood	F11	F8	F4	F2 1/2	F1.4				
		Spot	F16 1/2	F11 1/2	F8 1/2	F5.6	F4				
Focus140	4kw	Flood	F16 1/2	F11 1/2	F5.6 1/2	F4	F2.8	25Φ	11.8kg (17.1kg)	¥70,000 (¥86,000)	Soft Egg Crate ¥10,000
		Spot	F45	F32	F16 1/2	F11	F8				
	2.5kw	Flood	F16	F8 1/2	F5.6	F2.8 1/2	F2 1/2				
		Spot	F32 1/2	F32	F16 1/2	F11	F8				
Focus100	2.5kw	Flood	F8 1/2	F5.6	F2.8 1/2	F2	F1.4	25Φ	10.5kg (16.9kg)	¥67,000 (¥83,000)	Soft Egg Crate ¥10,000
		Spot	F22 1/2	F16	F8 1/2	F5.6	F4				
	1.2kw	Flood	F5.6	F2.8 1/2	F2 1/2	F1.4	F1				
		Spot	F16 1/2	F11 1/2	F8	F4 1/2	F2.8 1/2				
Focus77	1.2kw	Flood	F5.6 1/2	F4	F2.8	F1.4 1/2	F1	25Φ	10.3kg (16.7kg)	¥64,000 (¥80,000)	Soft Egg Crate ¥10,000
		Spot	F11	F8	F5.6	F2.8 1/2	F2				

Reflector

Downlight 530mmΦ ¥12,000
※ available for 1.2kw and 2.5kw.



Sunlight 530mmΦ ¥12,000
※ available for 1.2kw and 2.5kw.



※ Rental Fee doesn't include tax.

ARRI X 6kw HMI

RENTAL FEE ¥30,000
(Excluding burn time)

AD100A

max /up 90° /down 90°

ACCESSORIES

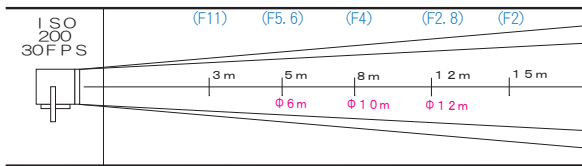

- Dimension 800mm (W) × 1,070mm (H) × 400mm (D) (except Barndoor)
- Weight 37kg ● Lens Diameter 500mm ● Spigot 25φ
- ARRI Ballast input power 100/200V(auto sensing)

※Scrim are not available for this Light.

- Space Silk (White Only) ¥3,000
- ARRI X Dome ¥12,000

ARRI X 4kw HMI

RENTAL FEE ¥20,000
(Excluding burn time)

C60A

max /up 90° /down 90°

ACCESSORIES

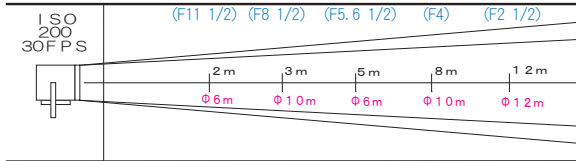

- Dimension 620mm (W) × 770mm (H) × 280mm (D) (except Barndoor)
- Weight 20kg ● Lens Diameter 400mm ● Spigot 25φ
- ARRI Ballast input power 100/200V(auto sensing)

※Scrim are not available for this Light.

- Space Silk (White Only) ¥2,000
- ARRI X Dome ¥12,000
- CUBE SILK Attachment 4kW/TB/CP/ARRIX4kW ¥500

ARRI X 2.5kw HMI

RENTAL FEE ¥18,000
(Excluding burn time)

C60A

max /up 90° /down 90°

ACCESSORIES

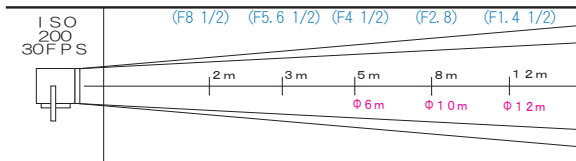

- Dimension 620mm (W) × 770mm (H) × 280mm (D) (except Barndoor)
- Weight 20kg ● Lens Diameter 400mm ● Spigot 25φ
- ARRI Ballast input power 100/200V(auto sensing)

※Scrim are not available for this Light.

- Space Silk (White Only) ¥2,000
- ARRI X Dome ¥12,000
- CUBE SILK Attachment 2.5kW/TB/CP/ARRIX2.5kW ¥500

ARRI X 1.2kw HMI

RENTAL FEE ¥12,000
(Excluding burn time)

2P

max /up 90° /down 90°

ACCESSORIES

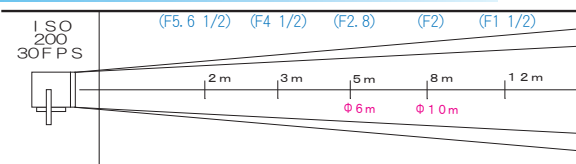

- Dimension 515mm (W) × 790mm (H) × 270mm (D) (except Barndoor)
- Weight 16kg ● Lens Diameter 300mm ● Spigot 17φ
- ARRI Ballast input power 100/200V(auto sensing)

※Scrim are not available for this Light.

- Space Silk (White Only) ¥2,000
- ARRI X Dome ¥8,000

ARRI X 575w HMI

RENTAL FEE ¥10,000

2P

max /up 90° /down 90°

ACCESSORIES

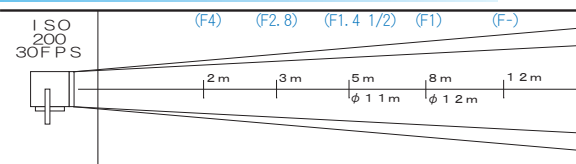

- Dimension 380mm (W) × 580mm (H) × 210mm (D) (except Barndoor)
- Weight 8.5kg ● Lens Diameter 205mm ● Spigot 17φ
- ARRI Ballast input power 100/200V(auto sensing)

※Scrim are not available for this Light.

- Space Silk (White Only) ¥2,000

※ Rental Fee doesn't include tax.

ARRI X 200w HMI

RENTAL FEE ¥10,000

2P

max /up 90° /down 90°

ACCESSORIES

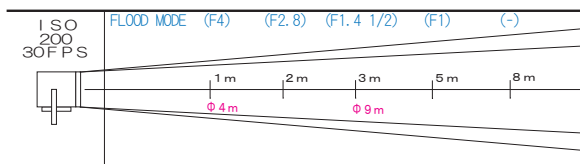

- Dimension 245mm (W) × 365mm (H) × 150mm (D) (except Barrdoor)
- Weight 3kg ● Lens Diameter 145mm ● Spigot 17φ
- ARRI Ballast input power 100/200V(auto sensing)

※Scrim are not available for this Light.

ARRIX DOME



ARRIX DOME 6k (2mΦ)
¥12,000

ARRIX DOME 2.5/4k (1.8mΦ)
¥12,000

ARRIX DOME 1.2k (1.6mΦ)
¥8,000

CUBE SILK



CUBE SILK ¥4,000
(1.2m×1.2m×1.2m)

CUBE SILK HALF ¥3,000
(1.2m×1.2m×0.7m)

- ARRIX 2.5/4k ~575w
- 5k BORDER ●4k MAIN

DARK VADER (Auto Shutter for DMX)

2P



- ARRI 18kCP ¥36,000(※)
- ARRI 12k ¥36,000(※)
- ARRI 6kCP ¥20,000
- ARRI 4kCP ¥20,000



- ARRI 2.5kCP ¥20,000
- ARRI 1.2k ¥15,000
- ARRI 575wCP ¥15,000

※Shutter opens vertically



Split BOX PS204 ¥5,000



575w WARP ZOOM ADAPTER ¥300

MAX MOVER

RENTAL FEE ¥30,000

2P



- Dimension 1160mm (W) × 965mm (H) × 300mm (D) (Except Light)
- Weight 37kg ● DMX512 ● Input Power 100V/200V

Available Lights

- ARRIMAX 18/12
- ARRI6kCP
- ARRIX6k
- ARRI18kCP/MAME
- ARRISUN12k
- ARRI24kT
- ARRI12kCP
- ARRISUN6k
- ARRISTUDIO12k

※ Rental Fee doesn't include tax.

ARRIMAX 18/12kw HMI

RENTAL FEE ¥80,000
(Excluding burn time)

AD100A max/up 90° /down 75°

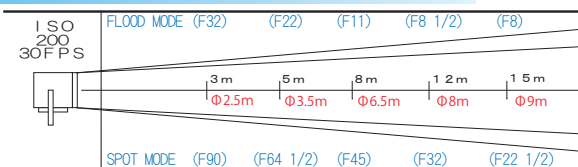

- Dimension 780mm (W) × 1230mm (H) × 950mm (D) (Without Barndoor)
- Weight 65kg ● Lens Diameter 650mm ● Spigot 28φ
- Input power 200V only

ACCESSORIES

- Extension cable (20m) ¥2,500
- SL size Chimera Plus Bank ¥13,000
- Barndoor ¥500
- Scrim ¥2,500

ARRIMAX 9kw HMI

RENTAL FEE ¥55,000
(Excluding burn time)

AD100A max/up 90° /down 90°

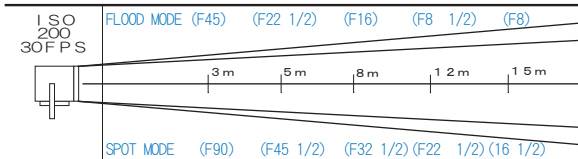

- Dimension 713mm (W) × 947mm (H) × 716mm (D) (Without Barndoor)
- Weight 39.5kg ● Lens Diameter 585mm ● Spigot 28φ
- Input power 200V only ● Including Barndoor

ACCESSORY

- Extension cable (20m) ¥2,500



Light leak prevention ring

ARRIMAX 2.5kw HMI

RENTAL FEE ¥25,000
(Excluding burn time)

C60A max/up 90° /down 90°

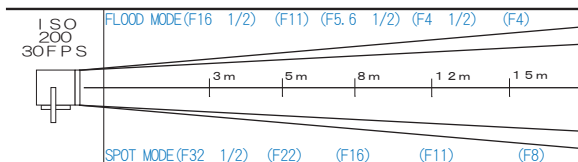

- Dimension 470mm (W) × 735mm (H) × 515mm (D) (Without Barndoor)
- Weight 19kg ● Lens Diameter 325mm ● Spigot 28φ
- Input Power 100/200V(auto sensing) ● Including Snoot
- Including Barndoor ※Use of Scrim or Shutter cause the lens breaking.

ACCESSORY

- Extension cable (8m) ¥1,000
- M size Chimera Plus Bank ¥11,000



Light leak prevention ring

ARRIMAX 1.8kw HMI

RENTAL FEE ¥18,000
(Excluding burn time)

C30A max/up 90° /down 75°

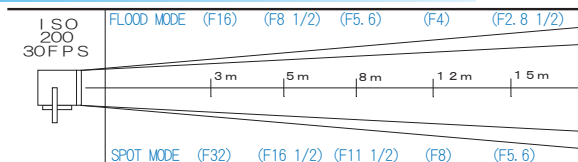

- Dimension 380mm (W) × 410mm (H) × 610mm (D) (Without Barndoor)
- Weight 10.5kg ● Lens Diameter 263mm ● Spigot 17φ
- Input power 100/200V(auto sensing) ● Including Snoot
- Including Barndoor ※Use of Scrim or Shutter cause the lens breaking.

ACCESSORIES

- Extension cable (8m) ¥1,000
- S size Chimera Plus Bank ¥7,000



Light leak prevention ring

ARRIMAX 800w HMI

RENTAL FEE ¥15,000

2P max/up 90° /down 90°

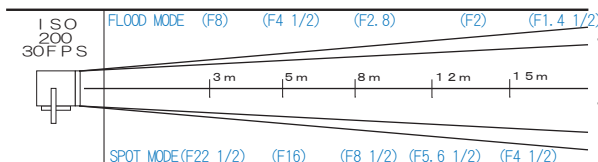

- Dimension 344mm (W) × 458mm (H) × 296mm (D) (Without Barndoor)
- Weight 7.8kg ● Lens Diameter 231mm ● Spigot 17φ
- Input power 100/200V(auto sensing) ● Including Snoot
- Including Barndoor ※Use of Scrim or Shutter cause the lens breaking.

ACCESSORY

- Extension cable (8m) ¥1,000
- S size Chimera Plus Bank ¥7,000



Light leak prevention ring

※ Rental Fee doesn't include tax.

ARRI SUN 12kw HMI

RENTAL FEE ¥55,000
(Excluding burn time)

AD100A max/up 90° /down 90°

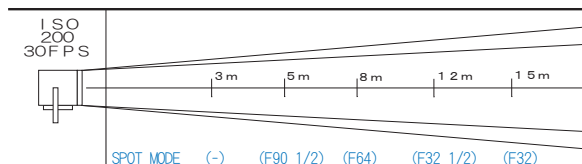

SPOT MODE	(-)	(F90 1/2)	(F64)	(F32 1/2)	(F32)
12kw lens set					
1. Very Narrow	(F90)	(F64)	(F45)	(F32)	(F22)
2. Narrow	(F64 1/2)	(F45)	(F22 1/2)	(F16 1/2)	(F16)
3. Medium	(F45 1/2)	(F32)	(F16 1/2)	(F11 1/2)	(F11)
4. Wide	(F32 1/2)	(F22)	(F11 1/2)	(F8 1/2)	(F8)
5. Frost	(F32)	(F16 1/2)	(F11 1/2)	(F8)	(F5.6 1/2)

※Use of Scrim or Shutter cause the lens breaking.

ACCESSORIES

- Extension cable (20m) ¥2,000
- Snoot ¥8,000
- Dimension 765mm (W) × 1,055mm (H) × 827mm (D) (Without Barndoor)
- Weight 48kg
- Lens Diameter 500mm
- Spigot 29φ
- Input power 200V

ARRI SUN 6kw HMI

RENTAL FEE ¥45,000
(Excluding burn time)

AD100A max/up 90° /down 90°

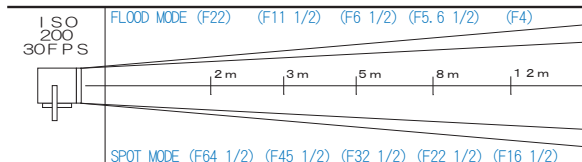

SPOT MODE	(F64 1/2)	(F45 1/2)	(F32 1/2)	(F22 1/2)	(F16 1/2)
FLOOD MODE	(F22)	(F11 1/2)	(F6 1/2)	(F5.6 1/2)	(F4)
1. Very Narrow	(F45)	(F32)	(F16 1/2)	(F16)	(F11)
2. Narrow	(F32)	(F22)	(F11)	(F8 1/2)	(F5.6 1/2)
3. Medium	(F22)	(F11 1/2)	(F8 1/2)	(F5.6 1/2)	(F5.6)
4. Wide	(F16)	(F8 1/2)	(F5.6 1/2)	(F4 1/2)	(F4)
5. Frost	(F11)	(F5.6 1/2)	(F4)	(F2.8)	(F1.4 1/2)

※Use of Scrim or Shutter cause the lens breaking.

ACCESSORIES

- Extension cable(20m) ¥2,000
- Snoot ¥5,000
- Chimera Plus Bank M size ¥11,000
- Dimension 590mm (W) × 915mm (H) × 640mm (D) (Without Barndoor)
- Weight 43kg
- Lens Diameter 420mm
- Spigot 25φ
- Input power 100/200V(auto sensing)

ARRI SUN 4kw HMI

RENTAL FEE ¥35,000
(Excluding burn time)

C60A max/up 90° /down 90°

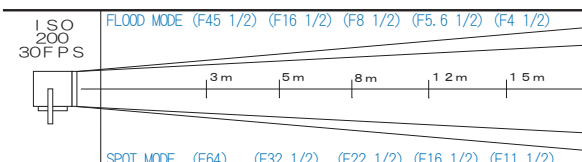

SPOT MODE	(F64)	(F32 1/2)	(F22 1/2)	(F16 1/2)	(F11 1/2)
FLOOD MODE	(F45 1/2)	(F16 1/2)	(F8 1/2)	(F5.6 1/2)	(F4 1/2)
4kw Lens					
1. Very Narrow	(F45 1/2)	(F32)	(F22)	(F11 1/2)	(F8 1/2)
2. Narrow	(F45)	(F22 1/2)	(F16)	(F8 1/2)	(F8)
3. Medium	(F22)	(F11 1/2)	(F8 1/2)	(F5.6 1/2)	(F4 1/2)
4. Wide	(F16 1/2)	(F8 1/2)	(F5.6 1/2)	(F4 1/2)	(F2.8 1/2)
5. Frost	(F11 1/2)	(F8)	(F4 1/2)	(F2.8 1/2)	(F2.8)

2. 5/4kw SPIL RING ※Use of Scrim or Shutter cause the lens breaking.

ACCESSORIES

- Extension cable(8m) ¥1,500
- Snoot ¥5,000
- Chimera Plus Bank M size ¥11,000
- Dimension 530mm (W) × 650mm (H) × 580mm (D) (Without Barndoor)
- Weight 21kg
- Lens Diameter 300mm
- Spigot 25φ
- Input power 100/200V(auto sensing)

ARRI SUN 2.5kw HMI

RENTAL FEE ¥25,000
(Excluding burn time)

C60A max/up 90° /down 90°

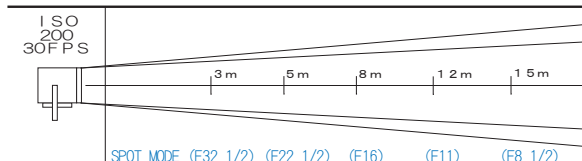

SPOT MODE	(F32 1/2)	(F22 1/2)	(F16)	(F11)	(F8 1/2)
2.5kw Lens					
1. Very Narrow	(F32 1/2)	(F22 1/2)	(F16)	(F11 1/2)	(F8 1/2)
2. Narrow	(F32)	(F16 1/2)	(F11)	(F8)	(F5.6 1/2)
3. Medium	(F16 1/2)	(F11)	(F5.6 1/2)	(F4 1/2)	(F4)
4. Wide	(F11 1/2)	(F8)	(F4 1/2)	(F2.8 1/2)	(F2.8)
5. Frost	(F8 1/2)	(F5.6 1/2)	(F4)	(F2.8)	(F2 1/2)

※Use of Scrim or Shutter cause the lens breaking.

ACCESSORIES

- Extension cable(8m) ¥1,500
- Snoot ¥5,000
- Chimera Plus Bank M size ¥11,000
- Dimension 420mm (W) × 540mm (H) × 460mm (D) (Without Barndoor)
- Weight 12kg
- Lens Diameter 250mm
- Spigot 17φ
- Input power 100/200V(auto sensing)

ARRI SUN 1.2kw HMI

RENTAL FEE ¥15,000
(Excluding burn time)

2P max/up 90° /down 90°

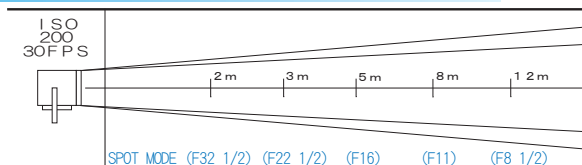

SPOT MODE	(F32 1/2)	(F22 1/2)	(F16)	(F11)	(F8 1/2)
1.2kw Lens					
1. Very Narrow	(F32)	(F16 1/2)	(F11 1/2)	(F8 1/2)	(F5.6 1/2)
2. Narrow	(F16 1/2)	(F11 1/2)	(F8)	(F4 1/2)	(F4)
3. Medium	(F11 1/2)	(F8)	(F4 1/2)	(F2.8 1/2)	(F2.8)
4. Wide	(F11)	(F5.6)	(F4)	(F2 1/2)	(F2)
5. Frost	(F5.6 1/2)	(F4)	(F2 1/2)	(F1.4 1/2)	(F1.4)

※Use of Scrim or Shutter cause the lens breaking.

ACCESSORIES

- Extension cable(8m) ¥1,000
- Snoot ¥3,000
- Chimera Plus Bank S size ¥7,000
- Dimension 270mm (W) × 340mm (H) × 320mm (D) (Without Barndoor)
- Weight 4.5kg
- Lens Diameter 175mm
- Spigot 17φ
- Input power 100/200V(auto sensing)

※ Rental Fee doesn't include tax.

ARRI SUN 575w HMI

RENTAL FEE ¥10,000

2P

max /up 90° /down 90°

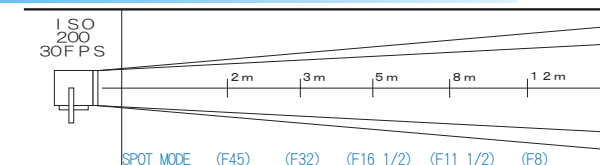

※Use of Scrim or Shutter cause the lens breaking.

ACCESSORIES

- Extension cable(8m) ¥1,000
- XS size Chimera Plus Bank ¥5,000

- Dimension 270mm (W) × 340mm (H) × 320mm (D) (Without Barndoor)
- Weight 4.5kg
- Lens Diameter 175mm
- Spigot 17φ
- Input power 100/200V(auto sensing)

ARRI SUN 200w HMI

RENTAL FEE ¥8,000

2P

max /up 90° /down 90°

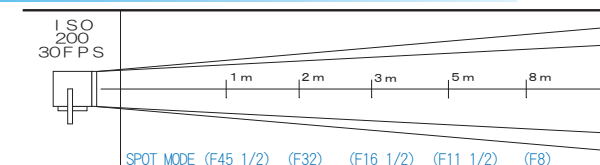

※Use of Scrim or Shutter cause the lens breaking.

ACCESSORIES

- XS size Chimera Plus Bank ¥5,000

- Dimension 210mm (W) × 270mm (H) × 270mm (D) (Without Barndoor)
- Weight 2kg
- Lens Diameter 120mm
- Spigot 17φ
- Input power 100/200V(auto sensing)

POCKET PAR 400w

RENTAL FEE ¥15,000

2P

max /up 90° /down 90°

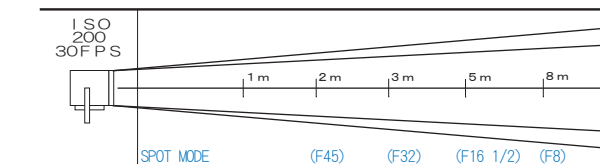

※Use of Scrim or Shutter cause the lens breaking.

ACCESSORIES

- XS size Chimera Plus Bank ¥5,000

- Dimension 250mm (W) × 300mm (H) × 350mm (D) (Without Barndoor)
- Weight 2.8kg
- Lens Diameter 130mm
- Spigot 17φ
- Input power 100/200V (auto sensing)

CYLINDER LIGHT KIT (for 400w PAR)

RENTAL FEE ¥5,000

2P

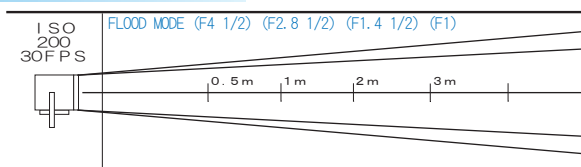

- Dimension 1,400mm (W) × 260mm (H) × 240mm (D)
- Weight 2kg (Without Light)
- Spigot 17φ

This is the diffuser for POCKET PAR 400w.

※ Rental Fee doesn't include tax.

POCKET PAR 200w

RENTAL FEE ¥12,000

2P

max /up 90° /down 90°

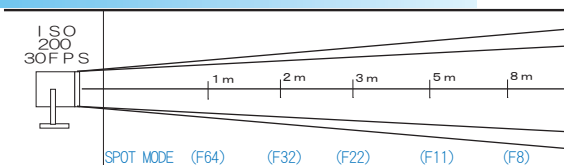

※Use of Scrim or Shutter cause the lens breaking.

ACCESSORIES

- XS size Chimera Plus Bank ¥5,000

- Dimension 215mm (W) × 250mm (H) × 330mm (D) (Without Barndoor)
- Weight 1.9kg
- Lens Diameter 95mm
- Spigot 17φ
- Input Power 100/200V (auto sensing)

CYLINDER LIGHT KIT (for 200w PAR) RENTAL FEE ¥5,000 2P



This is the diffuser for POCKET PAR 200w.

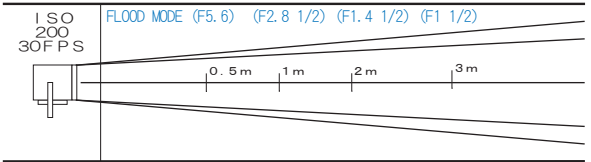

- Dimension 870mm (W) × 160mm (H) × 130mm (D)
- Weight 2kg (Without Light) ● Spigot 17φ

200w/400w PAR KIT ACCESSORIES 200w RENTAL FEE ¥6,000 400w RENTAL FEE ¥8,000



CHIMERA CYLINDER COVER CLEAR CYLINDER FROSTED CYLINDER

POCKET PAR 125w RENTAL FEE ¥12,000 2P

max/up 90° /down 90°



125w Lens
125par Snoot ¥1,080

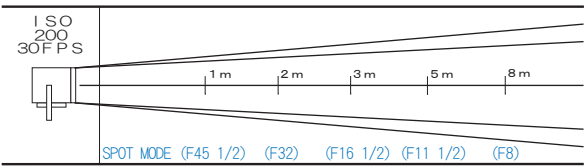

1. Narrow (F22) (F11 1/2) (F8 1/2) (F5.6) (F4)
 2. Medium (F16 1/2) (F8) (F5.6) (F4) (F2 1/2)
 3. Wide (F8 1/2) (F4) (F2.8) (F1.4 1/2) (F1)
 4. Frost (F8) (F2.8 1/2) (F2 1/2) (F1.4) (F-)
 5. Artificial (F16) (F8 1/2) (F5.6 1/2) (F4) (F2.8)
- light filter

ACCESSORIES

- Chimera Plus Bank
XXS size ¥5,000
- Dimension
130mm (W) × 170mm (H)
× 210mm (D) (Without Barndor)
- Weight 1kg
- Lens Diameter 78mm
- Spigot 17φ
- Input Power 100/200V

POCKET PAR 125w ELLI LENS RENTAL FEE ¥20,000 2P

max/up 90° /down 90°

(auto sensing)

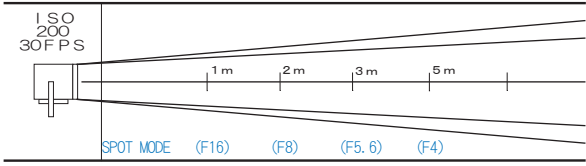

- Dimension
190mm (W) × 290mm (H)
× 395mm (D)
- Weight 4.9kg
- Lens Diameter 52mm
- Spigot 17φ
- Input Power 100/200V
(auto sensing)

ACCESSORIES

CYLINDER LIGHT KIT (for 125w PAR) RENTAL FEE ¥5,000 2P



This is the diffuser for POCKET PAR 125w.

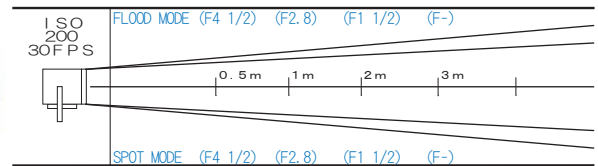

- Dimension 1,020mm (W) × 220mm (H) × 100mm (D)
- Weight 2.5kg (Without light) ● Spigot 17φ

FIBER SCOPE LENS RENTAL FEE ¥16,000

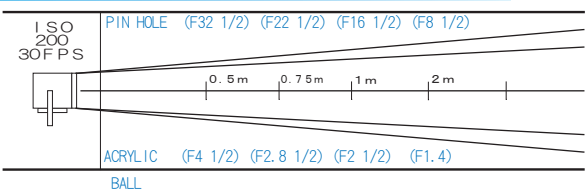

ACCESSORIES

- Lens Dimension
75mm (W) × 75mm (H)
× 310mm (D)
- Lens Diameter 60mm
- Pin Hole
0.3mm 0.6mm 0.9mm
- Fiber Cable length
3,000mm / 1,510mm

※ Rental Fee doesn't include tax.

800w Kobold ALL-WEATHER LIGHT RENTAL FEE ¥15,000 **2P** max/up 90° /down 90°

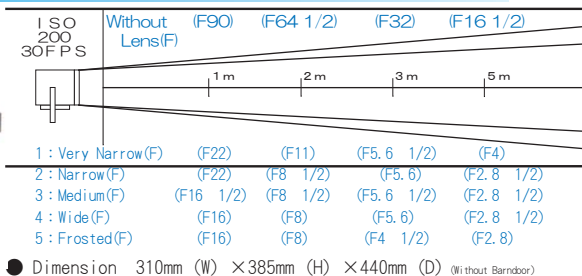

ACCESSORIES

- Weight 6kg
- Lens Diameter 210mm
- Spigot 17φ
- Input Power AC : 100/200V (auto sensing)
- Drip-proof HMI Light
- Lens set
- PLUS1 S size Chimera Plus Bank ¥5,000

400w Kobold ALL-WEATHER LIGHT RENTAL FEE ¥15,000 **2P** max/up 90° /down 90°

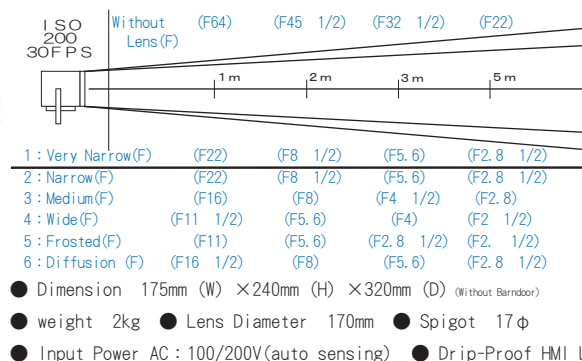

ACCESSORY

- Lens set



● Bron Adapter
For 400w / 200w
¥800

※Please notice the Lamp head is neither drip-proof nor dust-proof when you put this adapter on the lamp head

400w Kobold Cylinder RENTAL FEE ¥5,000

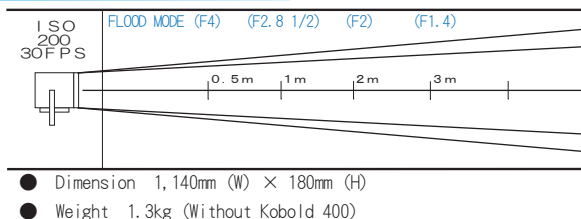

200w Kobold ALL-WEATHER LIGHT RENTAL FEE ¥12,000 **2P** max/up 90° /down 90°

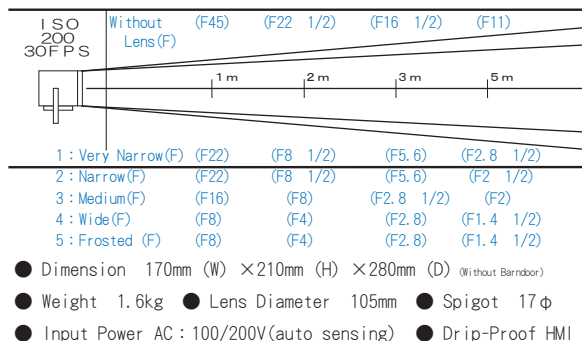

ACCESSORIES

- Lens set
- XS size Chimera Plus Bank ¥5,000



● Bron Adapter
for 400w / 200w
¥800

200w Kobold 6 (excluding light) RENTAL FEE ¥8,000 **2P**

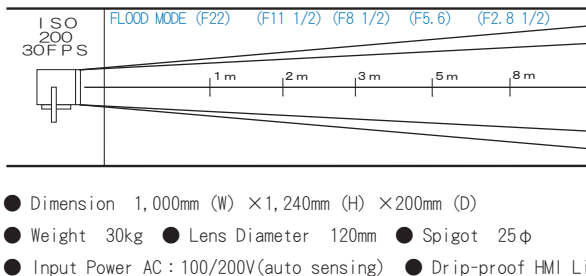

Down Light Adapter



¥3,000

※ Mounting slot is 260φ

DAYLIGHT

※ Rental Fee doesn't include tax.

400w JOKER

RENTAL FEE ¥15,000

2P

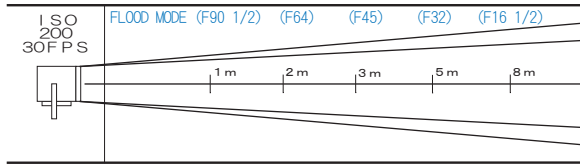

- Dimension 180mm (W) × 250mm (H) × 265mm (D) (Without Barndor)
- Weight 2kg ● Lens Diameter 120mm ● Spigot 17φ
- Input Power AC : 100/200V(auto sensing)

ACCESSORIES

- Including Lens no.1 ~ no.4
- Including 30 inch Pancake lantern
- Focus Reflector for 400w ¥1,000
- Jem Ball 22inch ¥2,000

400w JOKER TUBE

RENTAL FEE ¥5,000

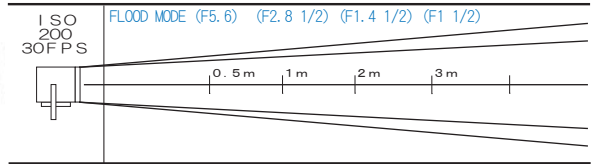

- Dimension 1,195mm (W) × 168mm (H)
- Weight 2kg (Without light)

200w JOKER

RENTAL FEE ¥12,000

2P

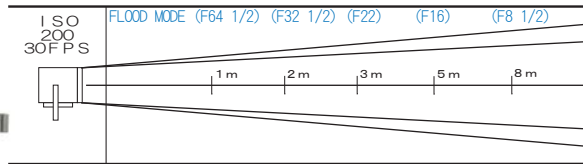

- Dimension 160mm (W) × 230mm (H) × 225mm (D) (Without Barndor)
- Weight 1kg ● Lens Diameter 78mm ● Spigot 17φ
- Input Power AC : 100/200V(auto sensing)

ACCESSORIES

- Including Lens no.1 ~ no.4
- Including 20 inch Pancake lantern
- Focus Reflector for 200w ¥1,000
- Jem Ball 22inch ¥2,000

200w JOKER TUBE

RENTAL FEE ¥5,000

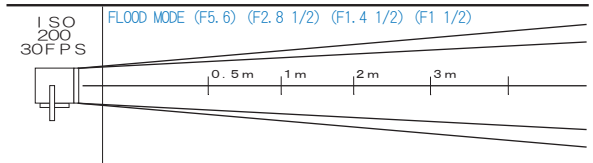

- Dimension 855mm (W) × 160mm (H)
- Weight 0.8kg (Without light)

OPTEX 2.5kw

RENTAL FEE ¥30,000

C60A

max/up 45° /down 45°

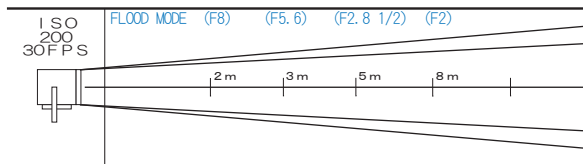

- Dimension 1,120mm (W) × 1,320mm (H) × 650mm (D)
- Weight 37.8kg ● Spigot 25φ
- Input Power 100/200V(auto sensing)

ACCESSORIES

- Extension cable(8m) ¥1,500
- Louver ¥2,000

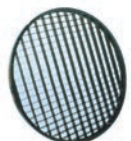

※ Rental Fee doesn't include tax.

OPTEX 1.2kw

RENTAL FEE ¥20,000

2P

max/up 45° /down 45°

ACCESSORIES

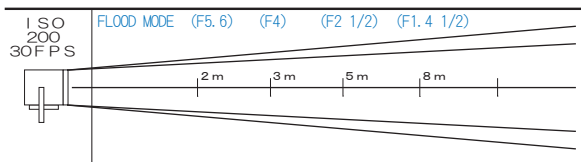

- Dimension 870mm (W) × 1,030mm (H) × 490mm (D)
- Weight 28kg ● Spigot 25φ
- Input Power 100/200V(auto sensing)

- Extension cable(8m) ¥1,500
- Louver ¥2,000

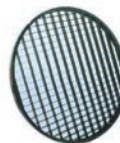

RDS HR-II (125w)

RENTAL FEE ¥10,000

2P

max/up 90° /down 90°

ACCESSORIES

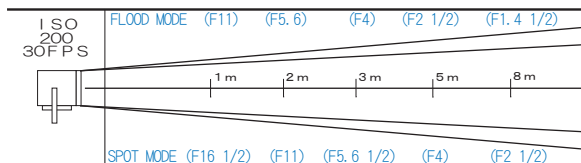

- Dimension 145mm (W) × 270mm (H) × 140mm (D) (Without Barndoor)
- Weight 1.2kg ● Lens Diameter 77mm ● Spigot 17φ
- Input Power AC : 100/200V(auto sensing)/DC : 24V



RDS AC/DC Ballast

DESISTI CHIZANO (200w)

RENTAL FEE ¥11,000

2P

max/up 90° /down 90°

ACCESSORIES

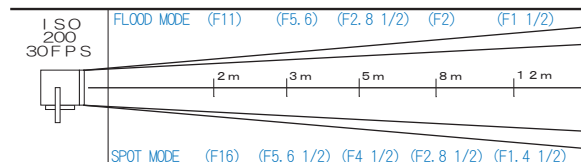

- Dimension 220mm (W) × 300mm (H) × 272mm (D) (Without Barndoor)
- Weight 2.8kg ● Lens Diameter 120mm ● Spigot 17φ
- Input Power AC : 100/200V(auto sensing)/DC : 24V

24w FREZZI LIGHT

RENTAL FEE ¥10,000

2P

ACCESSORIES

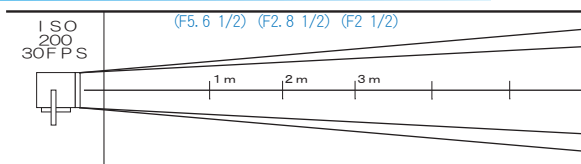

- Dimension 105mm (W) × 125mm (H) × 175mm (D)
- Weight 0.5kg ● Lens Diameter 42mm ● Spigot 17φ
- Input Power AC : 100/200V → DC : 12V (DC)
- Dedicated Power Source ● Dimension 100mm (W) × 55mm (H) × 200mm (D)



Including Diffuser

dedo light 400w HMI

RENTAL FEE ¥15,000

2P

max/up 90° /down 90°

ACCESSORIES

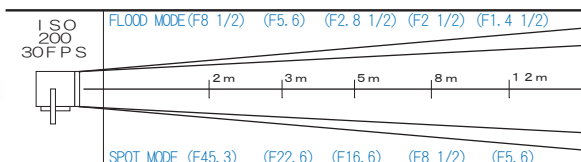

- Dimension 220mm (W) × 425mm (H) × 310mm (D) (Without Barndoor)
- Weight 4.6kg ● Lens Diameter 90mm ● Spigot 25φ
- Input Power 100/200V(auto sensing)

- Projection Attachment

※ Rental Fee doesn't include tax.

dedolight 200w HMI RENTAL FEE ¥12,000 2P max/up 90° /down 90°

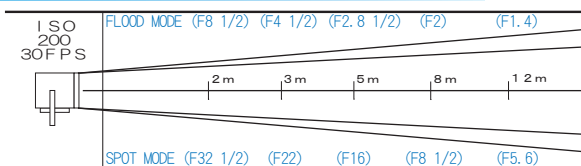

- Dimension 130mm (W) × 180mm (H) × 175mm (D) (without Barndoor)
- Weight 1.6kg ● Lens Diameter 60mm ● Spigot 17φ
- Input Power 100/200V(auto sensing)

ACCESSORIES

● Projection Attachment



SOURCE FOUR 400w RENTAL FEE ¥18,000 2P max/up 90° /down 90°

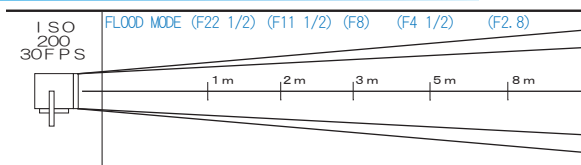

- Dimension 260mm (W) × 420mm (H) × 670mm (D)
- Weight 7.8kg
- Spigot 17φ

ACCESSORIES

- Lens (extra charge)
- 1 0° ¥5,000
- 1 9° ¥3,000
- 3 6° ¥3,000
- 5 0° ¥3,000

※Please see Page 62 for Source Four Accessories.

WARPZOOM 575w RENTAL FEE ¥18,000 2P max/up 90° /down 90°

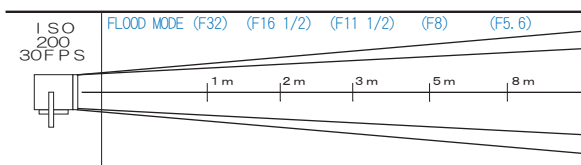

- Dimension 375mm (W) × 540mm (H) × 800mm (D)
- Weight 15kg
- Spigot 2.5φ

MICRO SYSTEM KIT (575w) RENTAL FEE ¥50,000 2P

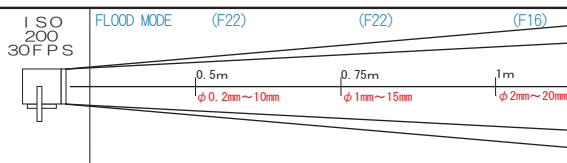

- Dimension 250mm (W) × 530mm (H) × 1,040mm (D)
- Weight 12kg ● Lens Diameter 90mm ● Spigot 25φ
- Input Power 100/200V(auto sensing)

● This Kit is the Pin Hall Light Kit that use 575w HMI UNI Focus Light. (φ0.2mm~2mm Pin Hall) This Kit use Gear Head.

MERCURY-VAPOR LAMP (400w) RENTAL FEE ¥5,000 2P

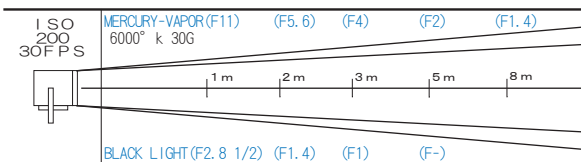

- Dimension 440mm (W) × 500mm (H) × 340mm (D)
- Weight 6kg ● Lens Diameter 440mm ● Spigot 25φ
- Dedicated Magnetic Ballast ● Input Power 100V

- Frosted Bulb
- Clear Bulb
- Sodium Bulb
- Black Light Bulb

※ Rental Fee doesn't include tax.

RDS 2.5kw HMI PIN SPOT

RENTAL FEE ¥25,000 **C60A** max/up 10° /down 45°

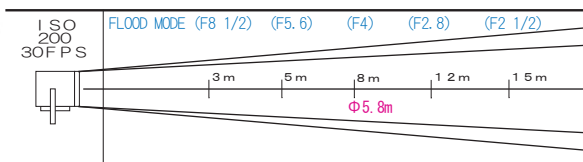

- Dimension 450mm (W) × 660mm (H) × 887mm (D) (Without Barndoor)
- Weight 30kg ● Lens Diameter 70mm ● Spigot 25φ
- Including Cutter And Iris
- Input Power 100/200V (auto sensing) Additional 100V is needed for Cooling FAN.

ACCESSORIES

- Extension cable (8m) ¥1,500
- DISK MACHINE ¥5,000
- SPIRAL MACHINE ¥3,000



2kw XENON PIN SPOT

RENTAL FEE ¥50,000 **C60A** max/up 10° /down 45°

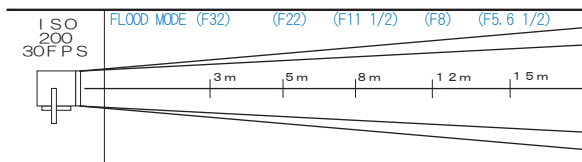

- Dimension 440mm (W) × 494mm (H) × 1490mm (D)
- Weight 57.5kg ● Lens Diameter 8inch · 3inch ● Spigot 25φ ※
- Input Power 100/200V (manual sensing) ● Including Iris
- Including Stand ※ Other stand is useful by using adapter dowel.

USHIO SEARCH LIGHT (3kw)

RENTAL FEE **C60A** max/up 90° /down 10°
¥50,000

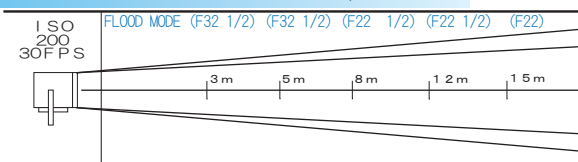

- Dimension 930mm (W) × 1,170mm (H) × 820mm (D) (Without Barndoor)
- Weight 67.5kg ● Lens Diameter 505mm ● Spigot 28φ
- Input Power 100/200V (manual sensing) ● Extension cable 10m + 5m (maximum 15m)

ACCESSORIES

- Downward type

max/up 0° /down 45°

USHIO SEARCH LIGHT (2kw)

RENTAL FEE **C60A** max/up 90° /down 10°
¥30,000

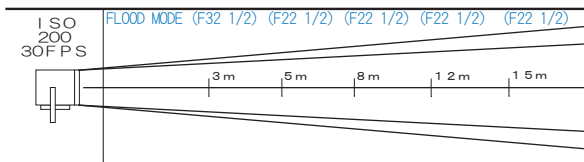

- Dimension 600mm (W) × 850mm (H) × 700mm (D) (Without Barndoor)
- Weight 31.4kg ● Lens Diameter 335mm ● Spigot 25φ
- Input Power 100/200V (manual sensing) ● Extension cable 10m + 5m (maximum 15m)

ACCESSORIES

- Downward type

max/up 0° /down 45°

USHIO SEARCH LIGHT (500w)

RENTAL FEE **C30A** max/up 90° /down 10°
¥15,000

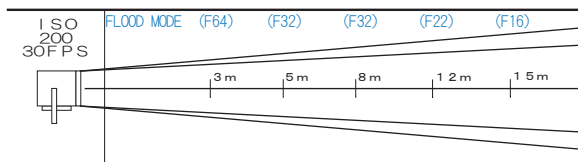

- Dimension 340mm (W) × 615mm (H) × 475mm (D) (Without Barndoor)
- Weight 13.6kg ● Lens Diameter 195mm ● Spigot 25φ
- Input Power 100/200V (auto sensing) ● Extension cable 10m + 5m (maximum 15m)

ACCESSORIES

- Downward type

max/up 0° /down 45°

※ Rental Fee doesn't include tax.

75w HAND SEARCH

RENTAL FEE ¥15,000

2P

ACCESSORIES

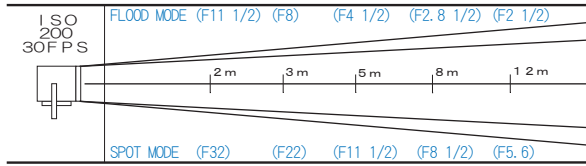

- Dimension 145mm (W) × 145mm (H) × 278mm (D)
- Weight 1.6kg ● Lens Diameter 120mm ● Spigot 17φ
- Dedicated Ballast ● Input Power 100V/200V / DC



Broncolor 575w HMI

※Please keep light switch always ON.
Please use ballast switch to turn on or off.

2P

max / up 90° / down 90°

RENTAL FEE ¥13,000



P65 Reflector
(Standard Equipment)

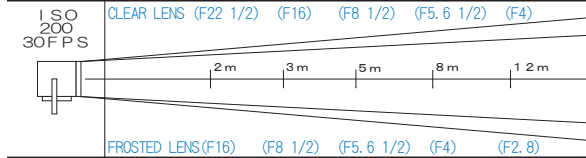

- Dimension 125mm (W) × 200mm (H) × 315mm (D) (Without Reflector)
- Weight 2.2kg ● Spigot 17φ ● Input Power 100/200V (auto sen)
- P 6 5 Opa Reflector Dimension 292mm (Diameter) × 242mm (D)
- Honeycomb Grid 3set ● Including Scrim



PULSO FLEX
with Egg crate
L ¥5,000
800mm X 1400mm
S ¥5,000
800mm X 800mm



P45 Reflector
(Option) ¥2,000

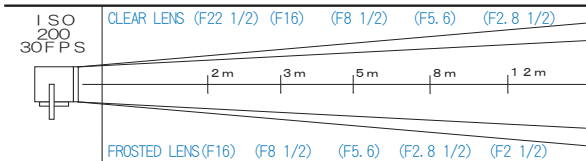

- P 4 5 Opa Reflector Dimension 300mm (Diameter) × 355mm (D)
- Honeycomb Grid 3set



BARN DOOR
(for P45 & P65 / P70)
¥1,000



P Soft Reflector
(Option) ¥2,500

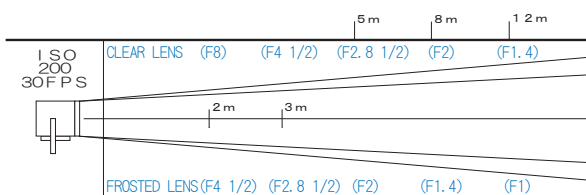

- P soft Opa Reflector Dimension 515mm (Diameter) × 200mm (D)
- Honeycomb Grid 3set ● Including Diffuser



OCTA FRAME
¥2,000



Spot Reflector
(Option) ¥3,000

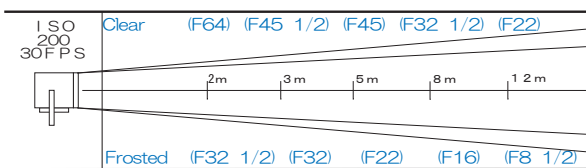

- Spot Reflector Dimension 445mm (Diameter) × 180mm (D)
- ※ Please handle carefully, when you attach or release Lens cap.
Imperfect attachment causes light failure or drop.

※Please Use Unbercup



Sun Reflector
(Option) ¥5,500

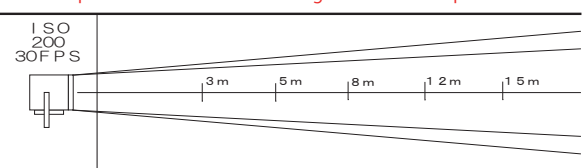

- Spot Reflector Dimension 445mm (Diameter) × 180mm (D)



BALCAR UMBRELLA 1500
1500Φ ¥2,000



Broncolor1020 1020Φ
※Do not use this for HMI
¥1,000

※ Rental Fee doesn't include tax.

Broncolor para

※Please keep light switch always ON.
Please use ballast switch to turn on or off.

2P

max /up 90° /down 90°



para 88 ¥15,000
● Dimension 880mm (Diameter)
● Spigot 1 7 Φ



para 133 ¥15,000
● Dimension 1,330mm (Diameter)
● Spigot 1 7 Φ



para 170 ¥23,000
● Dimension 1,700mm (Diameter)
● Spigot 2 9 Φ



para 220 ¥28,000
● Dimension 2,200mm (Diameter)
● Spigot 2 9 Φ



para 330 ¥44,000
● Dimension 3,300mm (Diameter)
● Spigot 2 9 Φ



※excluding lamp base.

※ Rental Fee doesn't include tax.

T-LIGHT (85kw)

RENTAL FEE ¥ 50,000

Cam Lock



Including Controller

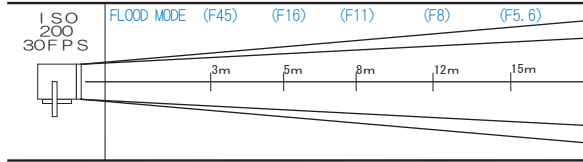

- Dimension 720mm (W) × 340mm (H) × 270mm (D)
- Weight 24kg ● Spigot 29mm
- Input Power 200V

HYPER BLAST (5kw)

RENTAL FEE ¥ 16,000

C30A

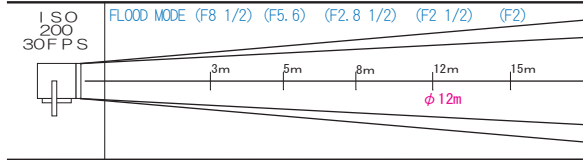

- Dimension 735mm (W) × 300mm (H) × 165mm (D)
- Weight 8.5kg ● Spigot 17mm
- Input Power 200V

HYPER BLAST (3kw)

RENTAL FEE ¥ 10,000

C30A

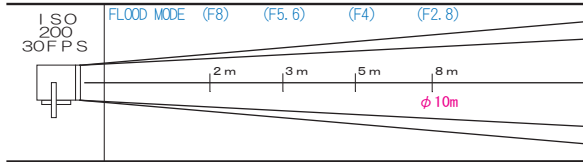

- Dimension 390mm (W) × 145mm (H) × 245mm (D)
- Weight 4kg ● Spigot 17mm
- Input Power 200V

PAR STROBE (1kw)

RENTAL FEE ¥ 8,000

2P

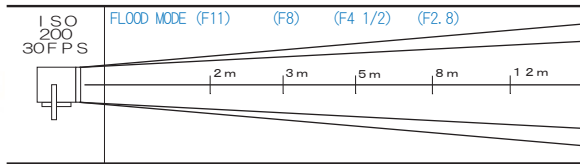

- Dimension 260mm (W) × 370mm (H) × 280mm (D)
- Weight 2.5kg ● Spigot 17mm ● Input Power 100V

ACCESSORIES

For HYPER BLAST & PAR STROBE



SCORO A4S 3200w

RENTAL FEE ¥ 11,000

2P

※Include Sync Cord



- Output Max 3200ws ~ Minimum 3ws
- f-number (Distance 2m, ISO100) 90 2/10
- Flash duration 0.1 (t0.5) 1/85 ~ 1/8000 (1/240 ~ 1/12000)
- Charging time 0.02 - 2.2 seconds (100V)
- Output can be adjusted in 1 / 10 of f11 increments. Display can be chosen from "Wattage" or "f-number" or "Allocation rate (%)"
- Input Power 100v ● Weight 12.5kg
- Dimension 288mm (W) × 190mm (D) × 453mm (H)



RFS Transmitter II
¥ 2,500

※ Rental Fee doesn't include tax.

Grafit A4 3200w

RENTAL FEE ¥ 10,000

2P

※ Include Sync Cord



- Output Max3200Ws ~ Minimum 30Ws
- f-number (Distance 2m, ISO100, using P70) 90 2/10
- Flash duration 0.1 (t0.5) 1/85~1/7500 (1/240~1/12000)
- Charging time 0.04 - 4.4 seconds (100V)
- Input Power 100 v / 200v ● Weight 12kg
- Dimension 288mm (W) × 180mm (D) × 408mm (H)
- Control range
6 7/10 f-stops for main connectors, 4f-stops for reserve connection, in 1/10 or 1/3 f-stop intervals. Display simultaneously in joules and f-stops, joules switchable to percentage.

※ There are 2 modelling light bulbs for 100V and 200V.
Please choose modeling light bulb for each voltage.



RFS Transmitter
¥ 2,500

Verso A2

RENTAL FEE ¥ 7,000

2P

ACCESSORY

※ Include Sync Cord



- Output: Max 1200Ws ~ Minimum 9.3Ws
- f-number (Distance 2m, ISO100, with P70) : 45 7/10
- Flash duration : 1200Ws : 1 / 500 (t 0.1) 1 / 1500 (t 0.5)
600Ws : 1 / 900 (t 0.1) 1 / 2500 (t 0.5)
300Ws : 1 / 1200 (t 0.1) 1 / 3500 (t 0.5)
- Charging time : 0.2~0.8 seconds (200-240V)、
0.3~1.0seconds (100V)、
0.3~1.5seconds (full charged battery)
- Input Power: 100V / 200V
- Weight: 7.5kg (only Generator)
- Dimension: 290mm (W) × 185mm (D) × 315mm (H)

● Control range

Channel 1 [without using channel 2] : Over 7 f-stops in 1/10 f-stop intervals[1:128]
Channel 1 and 2 or channel 2 : Over 6 f-stops in 1/10 f-stop intervals[1:64]

※ Channel 2 : [1:128] in case of using 2 lamp heads
※ There are 2 modelling light bulbs for 100V and 200V.
Please choose modeling light bulb for each voltage.



Power Pack
¥ 5,000



RFS Transmitter II
¥ 2,500

Verso A4

RENTAL FEE ¥ 10,000

2P

ACCESSORY

※ Include Sync Cord



- Output: Max 2400Ws ~ Minimum 18.7Ws
- f-number (Distance 2m, ISO100, with P70) : 64 7/10
- Flash duration : 2400Ws : 1 / 250 (t 0.1) 1 / 7500 (t 0.5)
1200Ws : 1 / 450 (t 0.1) 1 / 1250 (t 0.5)
600Ws : 1 / 600 (t 0.1) 1 / 1700 (t 0.5)
- Charging time : 0.3~1.7 (200-240V)、0.3~1.9 (100V)、
0.3~3.2 (full charged battery)
- Input Power: 100V / 200V
- Weight: 10.4kg (only Generator)
- Dimension: 290mm (W) × 185mm (D) × 380mm (H)

● Control range

Channel 1 [without using channel 2] : Over 7 f-stops in 1/10 f-stop intervals[1:128]
Channel 1 and 2 or channel 2 : Over 6 f-stops in 1/10 f-stop intervals[1:64]

※ Channel 2 : [1:128] in case of using 2 lamp heads
※ There are 2 modelling light bulbs for 100V and 200V.
Please choose modeling light bulb for each voltage.



Power Pack
¥ 5,000



RFS Transmitter II
¥ 2,500

※ Rental Fee doesn't include tax.

PULSO G LAMP BASE

¥6,000



Pulso G head

- Max Output 3200ws ● Input Power 100v
- Modeling Lamp 300w (100v)
- Dimension 145mm (W) × 270mm (H) × 320mm (D)
- Cable Length 5 m ● Weight 2.5kg ● Spigot 17φ

PULSO TWIN LAMP BASE

¥9,000

(P70 reflector and extension cable included)



Pulso Twin head

- Max Output 3200ws × 2 ● Input Power 100v
- Modeling Lamp 250w (100v)
- Dimension 145mm (W) × 270mm (H) × 320mm (D)
- Cable Length 5 m × 2 ● Weight 4kg ● Spigot 17φ

PULSO SPOT 4

¥10,000

This projects hard edged circles or triangles of light with no color fringing.



- Max Output 3200ws
- Input Power 100v
- Modeling Lamp 250w (100v)
- Dimension 290mm (W) × 250mm (H) × 370mm (D)
- Cable Length 5 m ● Weight 8.6kg
- Spigot 17φ

Including Optical Snoot.



SATELLITE STARO

¥10,000

The strong centre-oriented diffuser makes the light more brilliant and interesting than that of homogeneously illuminated softbox. The Satellite Staro is ideal as main lighting in fashion and beauty photography.



- Dimension 1020mm (W) × 970mm (H) × 250mm (D)
- Reflector Diameter 880mm × 880mm
- Weight 10kg
- Spigot 28φ

Including diffuser and honeycomb grid.



RING STROBE

¥10,000

The front glass allows light to evenly spill into Para



- Max Output 3200ws
- Input Power 100v
- Modeling Lamp 20w × 10
- Dimension 200 mm (W) × 80mm (H) × 200mm (D)
- Cable Length 5 m ● Weight 2.2kg
- Spigot 17φ

※Shown with a camera grip

Camera Grip



LIGHT BAR 120

¥10,000

This light head is ideally suited for lighting large areas such as backgrounds, architectural, and automotive subjects.



- Max Output 3200ws × 2 ● Input Power 100v
- Modeling Lamp 20w × 20 (100v)
- Dimension 1120mm (W) × 120mm (H) × 130mm (D)
- Cable Length 5 m × 2 ● Weight 6.8kg
- Spigot 17φ

Strobe Frame (2set)

¥2,400

※This frame can hang the strobe right above the subject.



- Dimension 1,200 mm (W) × 900mm (H) × 25mm (D)
- Weight 3.5kg
- Spigot 17φ

※Strobe head and umbrella excluding

BALLOON

¥5,000



- Diameter 50cm

※Do not use this for HMI



STROBE

★Precautions for use of lighting equipment.★

Grasp a plug or connector when unplugging out the connector. Otherwise may cause the damage of cable or other parts. Keep flammable materials away from light because light will be very hot during lighting and right after turn-off. Otherwise may cause fire or burn.

※Tungsten light may drastically darken by life of bulb, or by the condition of lens and reflector. ARC·SYSTEM provides the light equipment in best condition.

Please note that F-number in this catalog is the data calculated with equipment ARC·SYSTEM owns.

※ Rental Fee doesn't include tax.

ARRI 24kw



RENTAL FEE ¥50,000 **CamLock** max /up 45° /down 45°

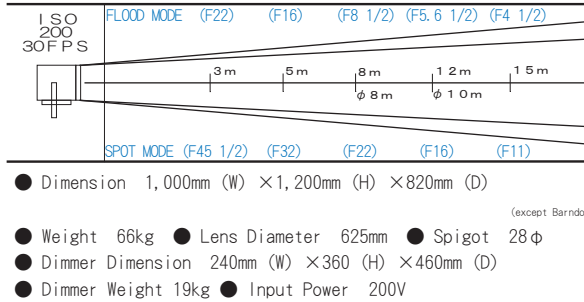

ACCESSORIES

- Extension cable (20m) ¥2,500
- Scrim ¥2,500
- SL size Chimera plus bank ¥13,000
- Shutter ¥5,000



24k Dimmer

ARRI STUDIO 12kw



RENTAL FEE ¥13,000 **AD100A** max /up 45° /down 45°

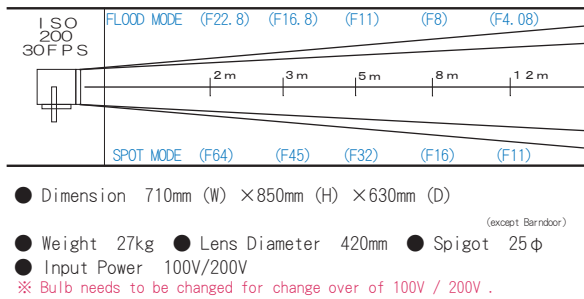

ACCESSORIES

- Scrim ¥2,000
- M size Chimera plus bank ¥11,000
- Shutter ¥3,000
- Snoot ¥5,000
- Bag-O-Light ¥30,000

※ Above accessories are same as accessories for 6KCP.

12kw PRIMO



RENTAL FEE ¥12,000 **AD100A** max /up 45° /down 45°

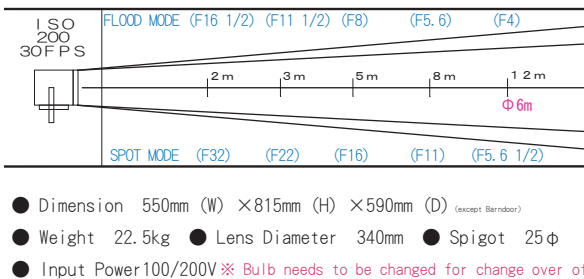

ACCESSORIES

- Scrim ¥1,500
- M size Chimera plus bank ¥11,000
- Shutter ¥2,000
- Snoot ¥5,000

10kw PRIMO



RENTAL FEE ¥10,000 **AD100A** max /up 45° /down 45°

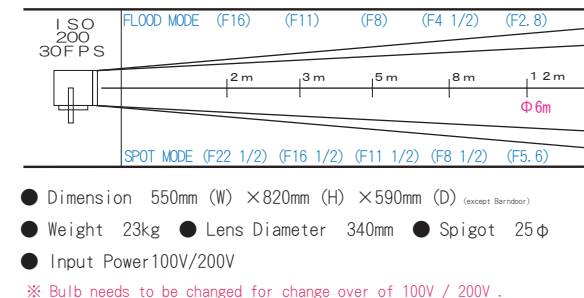

ACCESSORIES

- Scrim ¥1,500
- M size Chimera plus bank ¥11,000
- Shutter ¥2,000
- Snoot ¥5,000

※ Rental Fee doesn't include tax.

ARRI STUDIO 5kw

RENTAL FEE ¥ 7,000

C60A max /up 45° /down 45°

ACCESSORIES

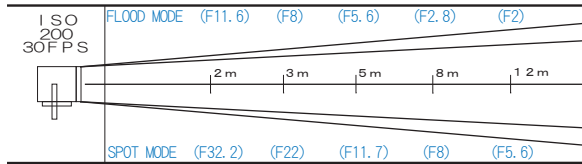

● Dimension 610mm (W) × 840mm (H) × 470mm (D)

● Weight 20kg ● Lens Diameter 310mm ● Spigot 25φ
● Input Power 100V/200V

※ Bulb needs to be changed for change over of 100V / 200V .

- Scrim ¥1,500
- M size
Chimera plus bank ¥11,000
- Shutter ¥2,000
- Snoot ¥5,000
- Bag-O-Light ¥30,000

※ Above accessories are same as accessories for 4KCP.

5kw PRIMO

RENTAL FEE ¥ 6,000

C60A max /up 45° /down 45°

ACCESSORIES

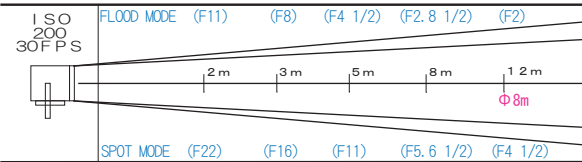

● Dimension 405mm (W) × 550mm (H) × 460mm (D) (except Barndoor)

● Weight 17kg ● Lens Diameter 240mm ● Spigot 25φ
● Input Power 100V/200V

※ Bulb needs to be changed for change over of 100V / 200V .

- Scrim ¥1,000
- S size
Chimera plus bank ¥7,000
- Shutter ¥1,500
- Snoot ¥3,000

ARRI STUDIO 2kw

RENTAL FEE ¥ 4,000

C30A max /up 90° /down 90°

ACCESSORIES

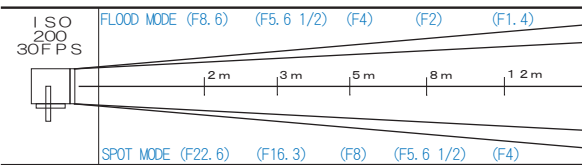

● Dimension 550mm (W) × 800mm (H) × 410mm (D) (except Barndoor)

● Weight 13.5kg ● Lens Diameter 250mm ● Spigot 25φ
● Input Power 100V/200V

※ Bulb needs to be changed for change over of 100V / 200V .

- Scrim ¥1,500
- S size
Chimera plus bank ¥7,000
- Shutter ¥2,000
- Snoot ¥3,000

※ Above accessories are same as accessories for 2.5KCP.

2kw PRIMO

RENTAL FEE ¥ 3,000

C30A max /up 45° /down 45°

ACCESSORIES

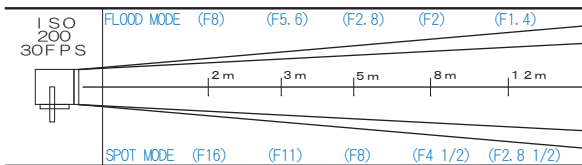

● Dimension 350mm (W) × 420mm (H) × 370mm (D) (except Barndoor)

● Weight 9kg ● Lens Diameter 180mm ● Spigot 25φ
● Input Power 100V/200V

※ Bulb needs to be changed for change over of 100V / 200V .

- Scrim ¥1,000
- S size
Chimera plus bank ¥7,000
- Shutter ¥1,000
- Snoot ¥2,000
- Eli Lens ¥5,000

ARRI STUDIO 1kw

RENTAL FEE ¥ 3,000

2P max /up 90° /down 90°

ACCESSORIES

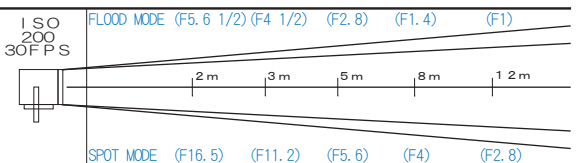

● Dimension 430mm (W) × 560mm (H) × 330mm (D) (except Barndoor)

● Weight 7.8kg ● Lens Diameter 180mm ● Spigot 17φ
● Input Power 100V/200V

※ Bulb needs to be changed for change over of 100V / 200V .

- Scrim ¥1,500
- S size
Chimera plus bank ¥7,000
- Shutter ¥1,000
- Snoot ¥2,000

※ Above accessories are same as accessories for 1.2KCP

※ Rental Fee doesn't include tax.

1kw PRIMO

RENTAL FEE ¥ 2,000

2P

max/up 45° /down 45°

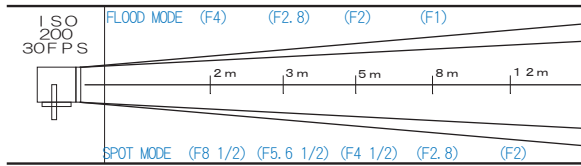

- Dimension 310mm (W) × 365mm (H) × 305mm (D) (except Barndoor)
- Weight 6kg ● Lens Diameter 155mm ● Spigot 17φ
- Input Power 100V

ACCESSORIES

- Scrim ¥1,000
- Shutter ¥1,000
- Snoot ¥1,000

ARRI JUNIOR 650w

RENTAL FEE ¥ 2,000

2P

max/up 90° /down 90°

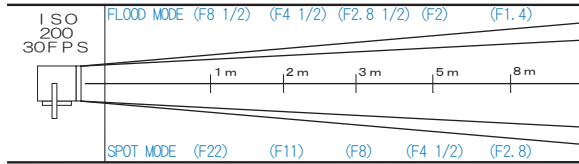

- Dimension 210mm (W) × 360mm (H) × 212mm (D) (except Barndoor)
- Weight 3kg ● Lens Diameter 112mm ● Spigot 17φ
- Input Power 100V

ACCESSORIES

- Scrim ¥500
- X S size Chimera plus bank ¥5,000
- Snoot ¥1,000

ARRI JUNIOR 300w

RENTAL FEE ¥ 1,500

2P

max/up 90° /down 90°

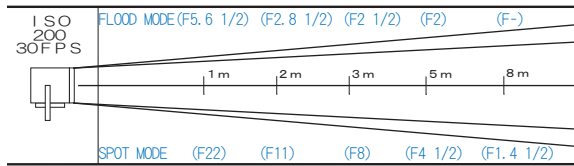

- Dimension 200mm (W) × 300mm (H) × 190mm (D) (except Barndoor)
- Weight 1.2kg ● Lens Diameter 80mm ● Spigot 17φ
- Input Power 100V

ACCESSORIES

- Scrim ¥500
- X S size Chimera plus bank ¥5,000
- Snoot ¥1,000

300w MIZAR

RENTAL FEE ¥ 1,500

2P

max/up 45° /down 45°

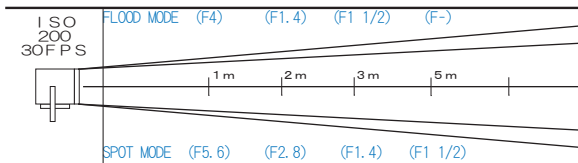

- Dimension 170mm (W) × 215mm (H) × 165mm (D) (except Barndoor)
- Weight 2kg ● Lens Diameter 75mm ● Spigot 17φ
- Input Power 100V

ACCESSORIES

- Snoot

200w k-1

RENTAL FEE ¥ 1,000

2P

max/up 45° /down 45°

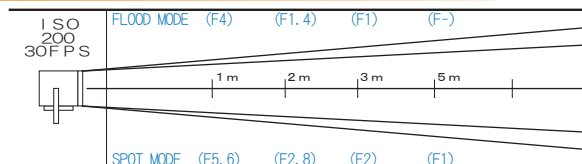

- Dimension 100mm (W) × 185mm (H) × 150mm (D) (except Barndoor)
- Weight 1.5kg ● Lens Diameter 75mm ● Spigot 17φ
- Input Power 100V

※ Rental Fee doesn't include tax.

ARRI JUNIOR 150w

RENTAL FEE ¥1,500

2P max/up 90° /down 90°

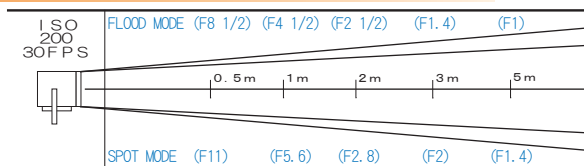

- Dimension 135mm (W) × 200mm (H) × 165mm (D) (except Barridor)
- Weight 1kg ● Lens Diameter 50mm ● Spigot 17φ
- Input Power 100V

ACCESSORIES

- Scrim ¥500
- Snoot ¥1,000

OPTEX AURA SOFT 4kw

RENTAL FEE ¥20,000

C60A max/up 45° /down 45°

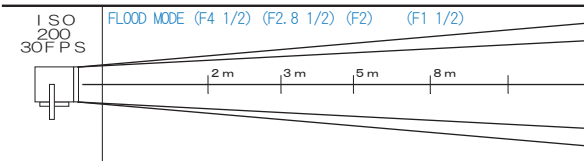

- Dimension 1,120mm (W) × 1,320mm (H) × 650mm (D)
- Weight 36kg ● Spigot 25φ ● Input Power 200V

ACCESSORIES

- Louver ¥2,000



OPTEX AURA SOFT 3kw

RENTAL FEE ¥10,000

C30A max/up 45° /down 45°

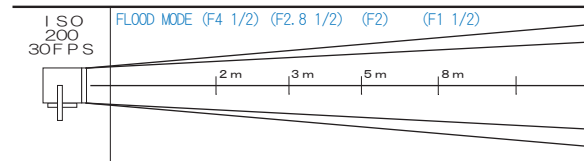

- Dimension 870mm (W) × 1,030mm (H) × 490mm (D)
- Weight 25kg ● Spigot 25φ ● Input Power 200V

ACCESSORIES

- Louver ¥2,000



ARRI LITE 2kw

RENTAL FEE ¥4,000

C30A max/up 45° /down 45°

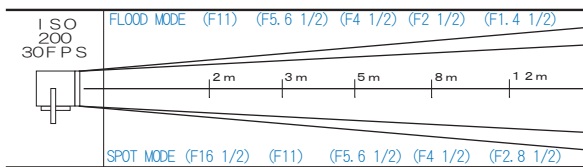

- Dimension 280mm (W) × 330mm (H) × 310mm (D) (except Barridor)
- Weight 4kg ● Spigot 17φ

Caution for handling.

Please be sure to use explosion-proof net.

ARRI LITE 1kw

RENTAL FEE ¥3,000

2P max/up 60° /down 60°

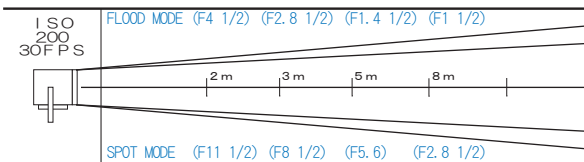

- Dimension 200mm (W) × 210mm (H) × 220mm (D) (except Barridor)
- Weight 2.4kg ● Spigot 17φ

Caution for handling.

Please be sure to use explosion-proof net.

※ Rental Fee doesn't include tax.

LOWELL 1kw

RENTAL FEE ¥2,000

2P max /up 60° /down 60°

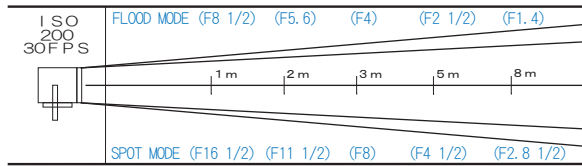

- Dimension 235mm (W) × 200mm (H) × 170mm (D) (except Barndoor)
- Weight 2kg ● Spigot 17φ
- Input Power 100V

ARRILITE 750w Plus

RENTAL FEE ¥3,000

2P max /up 60° /down 60°

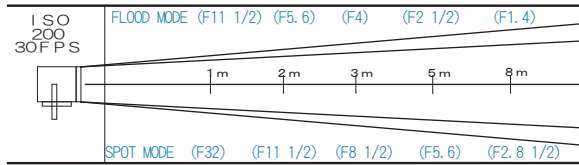

- Dimension 188mm (W) × 226 mm (H) × 224mm (D) (except Barndoor)
- Weight 1.6kg ● Spigot 17φ ● Input Power 100V
- 2 Lights set

ARRI LITE 500w

RENTAL FEE ¥5,000

2P max /up 60° /down 60°

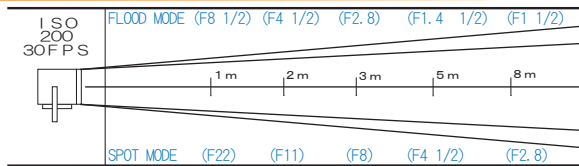

Caution for handling.

Please be sure to use explosion-proof net.

- Dimension 155mm (W) × 190mm (H) × 220mm (D) (except Barndoor)
- Weight 1.2kg ● Spigot 17φ
- 3 Lights set

BLACKJACK 400

RENTAL FEE ¥15,000

2P max /up 60° /down 60°

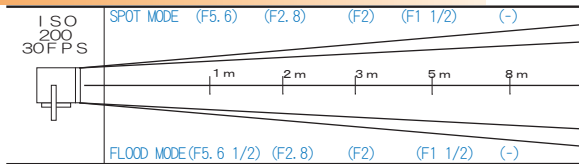

- Spot&Flood Lens Include
- D&T Light Bulb Include

- 1: SPOT MODE
- | | | | | | | |
|---------------|-----------|-----------|----------|------------|------------|--------|
| 1: SPOT LENS | (F22 1/2) | (F11 1/2) | (F8 1/2) | (F5.6) | (F2.8 1/2) | (F2) |
| 2: FLOOD LENS | (F11 1/2) | (F8) | (F4 1/2) | (F2.8 1/2) | (F2) | (F1.4) |
- 2: FLOOD MODE
- | | | | | | | |
|---------------|-------|--------|------------|------------|--------|--------|
| 1: SPOT LENS | (F11) | (F5.6) | (F2.8 1/2) | (F2) | (F1.4) | (F1) |
| 2: FLOOD LENS | (F8) | (F4) | (F2 1/2) | (F1.4 1/2) | (F1) | (F0.8) |
- Dimension 270mm (W) × 175mm (H) × 260mm (D) (except Barndoor)
 - Weight 3.18kg ● Lens Diameter 130mm ● Spigot 17φ
 - Input Power 100/200V (Automatically switched)

500w PULSAR

RENTAL FEE ¥5,000

2P max /up 60° /down 60°

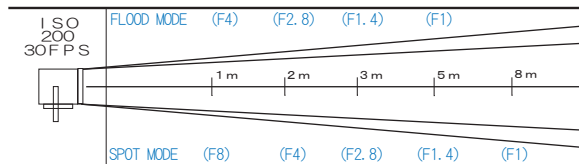

ACCESSORIES

- Including Scrim
- S size
- Chimera plus bank ¥5,000

- Dimension 135mm (W) × 220mm (H) × 170mm (D) (except Barndoor)
- Weight 1.5kg ● Spigot 17φ
- Input Power 100V / 200V / 24V ● 3 Lights set

※ Rental Fee doesn't include tax.

LOWELL 250w PRO

RENTAL FEE ¥ 6, 000

2P max/up 60° /down 60°

ACCESSORIES

• Snoot / Lens set

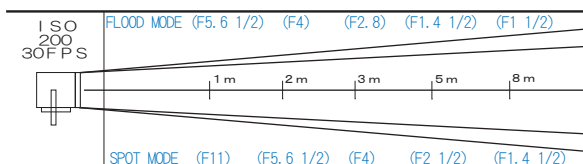

- Dimension 93mm (W) × 185mm (H) × 120mm (D) (except Barndoor)
- Weight 1.1kg ● Spigot 17φ ● 3 Lights set
- Input Power 100V

5kw BORDER

RENTAL FEE ¥ 5, 000

C60A max/up 45° /down 45°

Caution for handling.

Please be sure to use explosion-proof net.

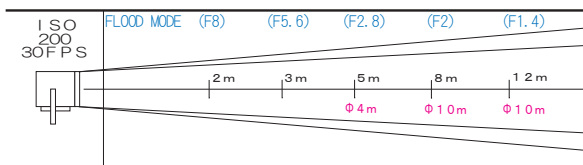

- Dimension 730mm (W) × 740mm (H) × 330mm (D)
- Weight 16kg ● Spigot 25φ ● Input Power 100V/200V
- ※ Bulb needs to be changed for change over of 100V / 200V .

3kw BORDER

RENTAL FEE ¥ 2, 500

C30A max/up 45° /down 45°

Caution for handling

Please be sure to use explosion-proof net.

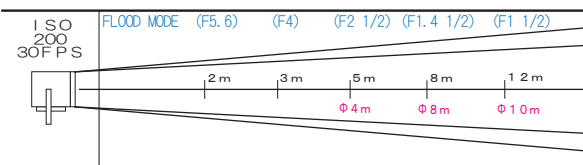

- Dimension 730mm (W) × 530mm (H) × 270mm (D)
- Weight 15kg ● Spigot 17φ ● Input Power 100V/200V
- ※ Bulb needs to be changed for change over of 100V / 200V .

4kw MAIN

RENTAL FEE ¥ 4, 000

C30A max/up 90° /down 90°

Caution for handling

Please be sure to use explosion-proof net.

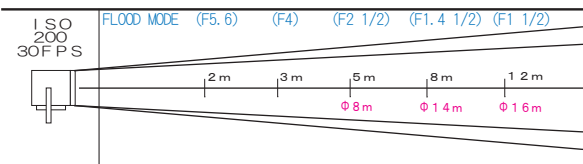

- Dimension 800mm (W) × 830mm (H) × 370mm (D)
- Weight 13kg ● Spigot 25φ ● Input Power 100V

SPACE LIGHT 3kw/4. 5kw

RENTAL FEE ¥ 5, 500 / ¥ 6, 500

C30A Only for down 90°

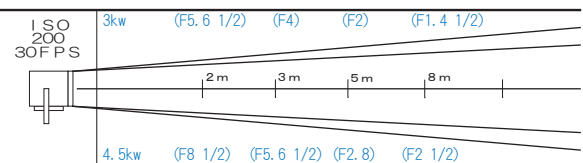

Black Diffuser

Silk Diffuser



- Dimension 710mm (W) × 710mm (H) × 540mm (D)
- Weight 7kg ● Input Power 100V

● Diffuser
850mmφ × 930mm (H)

※ Rental Fee doesn't include tax.

4kw/2.4kw HORIZONT

RENTAL FEE ¥ 6,000

C30A



★ Can be connected up to 3 sets.

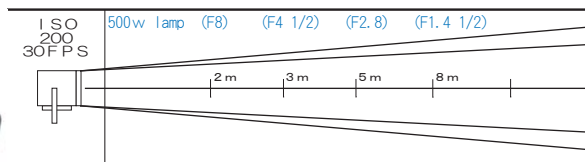

- Dimension 960mm (W) × 320mm (H) × 385mm (D)
- Weight 24.4kg ● Input Power 100V
- 500w lamp kit 4kw (500w×8) 40A
- 300w lamp kit 2.4kw (300w×8) 24A



Connector

4kw OCT LIGHT

RENTAL FEE ¥ 6,500

2P

max/up 90° /down 90°

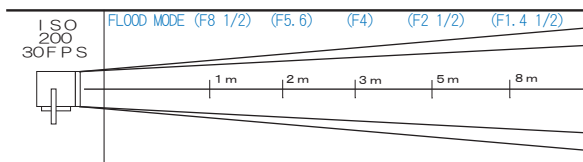

- Dimension 700mm (W) × 810mm (H) × 250mm (D)
- Weight 13kg ● Spigot 25φ
- Input Power 100v (1kw球×4)

ACCESSORIES

- M size Chimera plus bank ¥11,000
- Space Silk ¥2,000

1.8kw BURGER

RENTAL FEE ¥ 4,000

2P

max/up 45° /down 45°

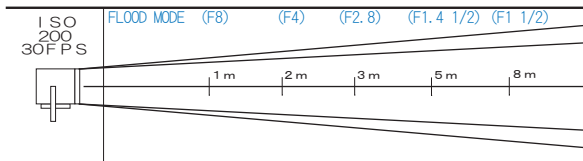
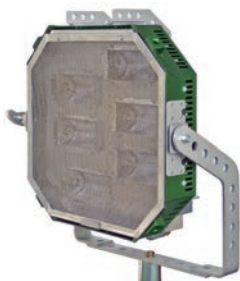

- Dimension 530mm (W) × 670mm (H) × 240mm (D)
- Weight 9.4kg ● Spigot 25φ
- Input Power 100v (300w × 6)

ACCESSORIES

- Chimera plus bank付属



ON/OFF switch

ARRI MINI FLOOD 500w/750w

RENTAL FEE

¥ 2,500

2P

max/up 90° /down 90°

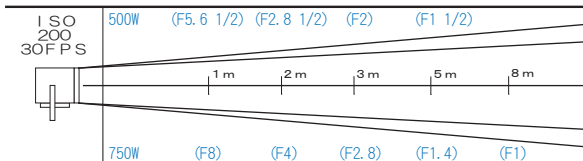

- Dimension 265mm (W) × 225mm (H) × 110mm (D) (including Barndoor)
- Weight 2kg ● Spigot 17φ ● Input Power 100V

TOTA 500w/750w

RENTAL FEE ¥ 2,000

2P

max/up 90° /down 90°

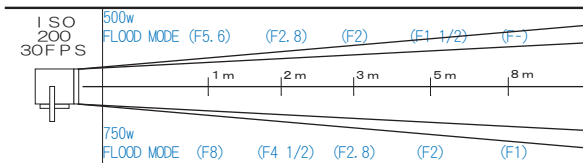

- Dimension 290mm (W) × 75mm (H) × 50mm (D) (including Barndoor)
- Weight 0.5kg ● Spigot 17φ
- Input Power 100V

Caution for handling

Please be sure to use with explosion-proof net.

※ Rental Fee doesn't include tax.

V LIGHT (500w)

RENTAL FEE ¥6,000

2P

max/up 90° /down 90°

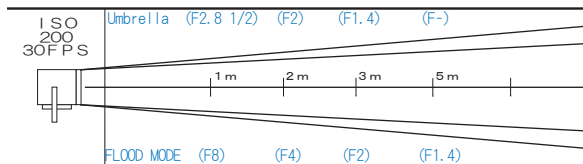

- Dimension 180mm (W) ×250mm (H) ×250mm (D) (With Barndoor)
- Weight 1.0kg ● Spigot 17φ ● Umbrella Diameter 690mm
- Input Power 100V ● Set of 4 fixtures.

8×8 RIFA LIGHT 500w/850w

RENTAL FEE ¥3,500

2P

max/up 60° /down 60°

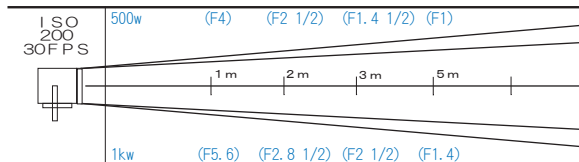

Caution for handling

Please do not fold until the lamp gets cold

- Dimension 800mm (W) ×800mm (H) ×600mm (D)
- Weight 2kg ● Spigot 17φ ● Input Power 100V

5×5 RIFA LIGHT 500w

RENTAL FEE ¥2,500

2P

max/up 60° /down 60°

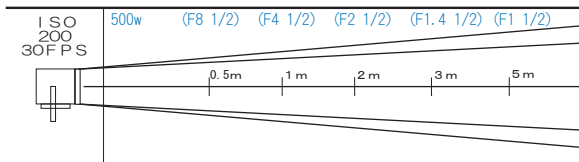

Caution for handling

1kw and bigger bulbs are not available for this RIFA. Please do not fold until the lamp gets cold

- Dimension 525mm (W) ×525mm (H) ×500mm (D)
- Weight 1.4kg ● Spigot 17φ ● Input Power 100V

4×4 RIFA LIGHT 300w

RENTAL FEE ¥2,500

2P

max/up 60° /down 60°

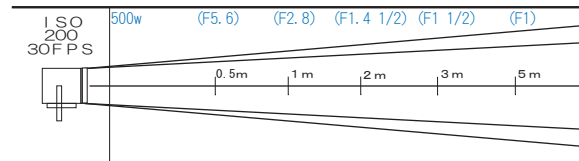

Caution for handling

1kw and bigger bulbs are not available for this RIFA. Please do not fold until the lamp gets cold

- Dimension 410mm (W) ×410mm (H) ×400mm (D)
- Weight 0.8kg ● Spigot 17φ ● Input Power 100V

CHIMERA LANTERN 500w/1kw

RENTAL FEE ¥3,000

2P

max/up 90° /down 90°

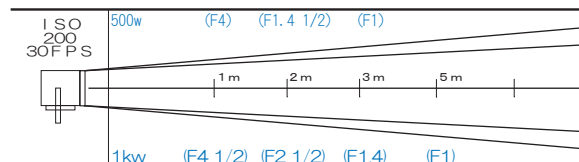

- Dimension L size 600mm (W) ×700mm (H) ×600mm (D)
S size 400mm (W) ×450mm (H) ×400mm (D)
- Weight L size 1.6kg S size 1.5kg ● Input Power 100V

※ Rental Fee doesn't include tax.

JEM BALL 19 / 500w (T)

2P max/up 90° /down 90°

RENTAL FEE ¥ 3,000

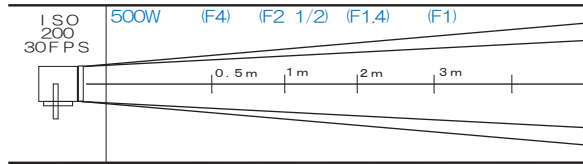

- Dimension 470mm (W) × 470mm (H) × 630mm (D)
- Weight 1.7kg ● Input Power 100V

JEM BALL 22 / 1kw (T)

2P max/up 90° /down 90°

RENTAL FEE ¥ 4,000

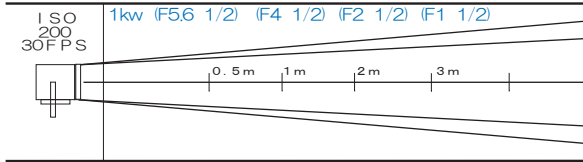

- Dimension 600mm (W) × 600mm (H) × 630mm (D)
- Weight 1.9kg ● Input Power 100V

SOFT LIGHT 1kw

2P max/up 60° /down 60°

RENTAL FEE ¥ 4,000

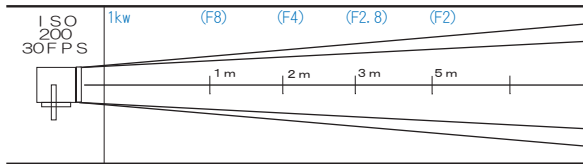

- Dimension 530mm (W) × 530mm (H) × 420mm (D)
- Weight 5kg ● Spigot 17φ ● Input Power 100V

ACCESSORY



• Including JEM BALL 22

DINO 24

Cam Lock max/up 90° /down 90°

RENTAL FEE ¥ 30,000

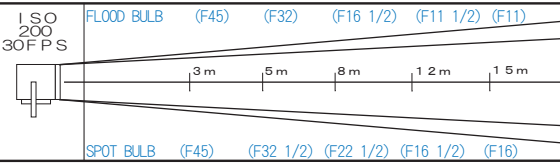

- Light Dimension 1,750mm (W) × 1,320mm (H) × 190mm (D)
- Weight 82kg ● Spigot 28φ ● Input Power 100V / 200V
- Bulb 1kw/500w (Narrow • Very Narrow • Medium) 300w (Narrow • Medium) ※ Bulb needs to be changed for change over of 100V / 200V.

ACCESSORIES

- 2P Connector (2P 6ch multi cord)

Input



DINO 16

Cam Lock max/up 90° /down 90°

RENTAL FEE ¥ 20,000

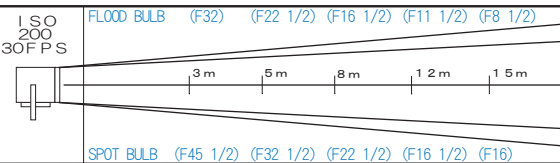

- Light Dimension 1,220mm (W) × 1,280mm (H) × 190mm (D)
- Weight 53kg ● Spigot 28φ ● Input Power 100V / 200V
- Bulb 1kw/500w (Narrow • Very Narrow • Medium) 300w (Narrow • Medium) ※ Bulb needs to be changed for change over of 100V / 200V.

ACCESSORIES

- 2P Connector (2P 6ch multi cord)

Input



※ Rental Fee doesn't include tax.

DINO 9

RENTAL FEE ¥15,000 **Cam Lock** max /up 90° /down 90°

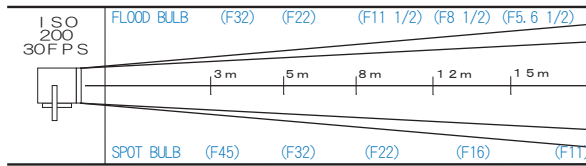

- Light Dimension 920mm (W) × 1,050mm (H) × 190mm (D)
- Weight 33kg ● Spigot 28φ ● Input Power 100V / 200V
- Bulb 1 k w / 5 0 0 w (Narrow · Very Narrow · Medium)
3 0 0 w (Narrow · Medium) ※ Bulb needs to be changed for change over of 100V / 200V.

ACCESSORIES

- 2P Connector (2P 6ch multi cord)

Input



DINO STRAIGHT6

RENTAL FEE ¥8,000 **2P** max /up 90° /down 90°

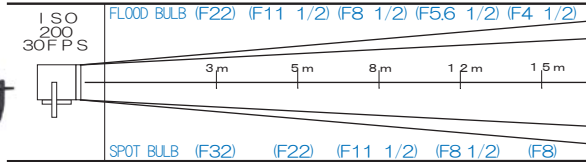

- Light Dimension 1,550mm (W) × 370mm (H) × 220mm (D)
- Weight 19.6kg ● Spigot 25φ ● Input Power 100V / 200V(2P × 6)
- Bulb 1 k w / 5 0 0 w (Narrow · Very Narrow · Medium)
3 0 0 w (Narrow · Medium) ※ Bulb needs to be changed for change over of 100V / 200V.

ACCESSORIES

MINI BRUTE 9

RENTAL FEE ¥8,000 **C30A** max /up 90° /down 90°

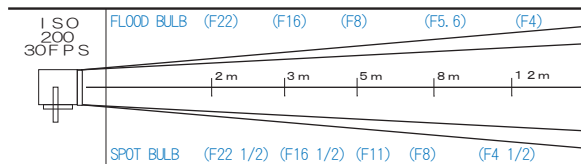

- Light Dimension 650mm (W) × 430mm (H) × 79mm (D)
- Weight 12kg ● Spigot 17φ
- Input Power 100V ● Bulb 5 0 0 w (Narrow · Very Narrow · Medium)
3 0 0 w (Narrow · Medium)

ACCESSORIES

- C60A Connector including

※ Bulb needs to be changed for change over of 100V / 200V.

MINI BRUTE 2

RENTAL FEE ¥2,000 **2P** max /up 90° /down 90°

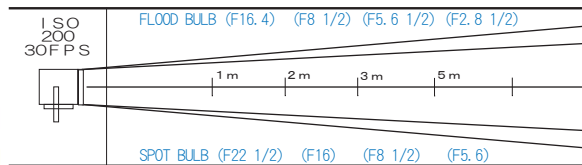

- Light Dimension 325mm (W) × 245mm (H) × 85mm (D) (Except Barndoor)
- Weight 2.2kg ● Spigot 17φ
- Input Power 100V ● Bulb 5 0 0 w (Narrow · Very Narrow · Medium)
3 0 0 w (Narrow · Medium)

※ Bulb needs to be changed for change over of 100V / 200V.

MINI BRUTE 1

RENTAL FEE ¥1,000 **2P** max /up 90° /down 90°

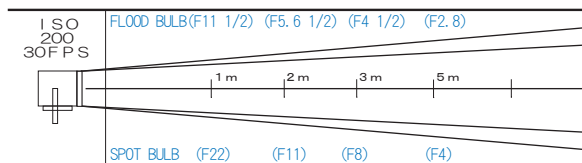

- Light Dimension 240mm (W) × 240mm (H) × 80mm (D) (Except Barndoor)
- Weight 1.4kg ● Spigot 17φ
- Input Power 100V ● Bulb 5 0 0 w (Narrow · Very Narrow · Medium)
3 0 0 w (Narrow · Medium)

※ Bulb needs to be changed for change over of 100V / 200V.

※ Rental Fee doesn't include tax.

ARRI RUBY 7 (7kw/3.5kw)

RENTAL FEE ¥ 12,000

AD100A

max/up 90° /down 90°

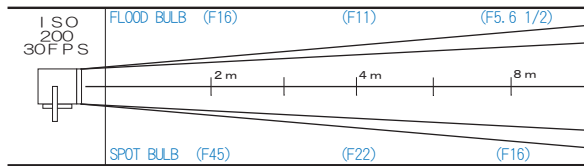

※ Bulb needs to be changed for change over of 100V / 200V.

- Light Dimension 910mm (W) × 890mm (H) × 340mm (D)
- Weight 27kg ● Lens Diameter 185mm × 7 ● Spigot 25φ
- Input Power 100V/200V (Remote Controller/100V only)
- Bulb 1kw/500w (Narrow · Very Narrow · Medium) 300w (Narrow · Medium)

PAR64 (Black or Silver)

RENTAL FEE ¥ 2,000

2P

max/up 90° /down 90°

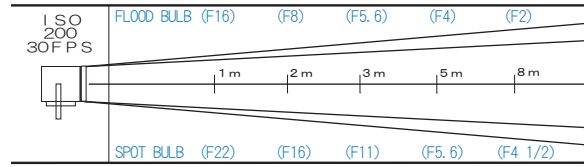

※ Bulb needs to be changed for change over of 100V / 200V.

- Light Dimension 230mm (W) × 335mm (H) × 420mm (D)
- Weight 3kg ● Lens Diameter 185mm ● Spigot 17φ
- Input Power 100V/200V
- Bulb 1kw/500w (Narrow · Very Narrow · Medium) 300w (Narrow · Medium)

PAR64 Short (Black or Silver)

RENTAL FEE ¥ 2,000

2P

max/up 90° /down 90°

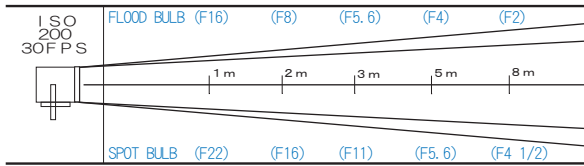

※ Bulb needs to be changed for change over of 100V / 200V.

- Light Dimension 230mm (W) × 335mm (H) × 310mm (D)
- Weight 2kg ● Lens Diameter 185mm ● Spigot 17φ
- Input Power 100V/200V
- Bulb 1kw/500w (Narrow · Very Narrow · Medium) 300w (Narrow · Medium)

PAR36

RENTAL FEE ¥ 1,500

2P

max/up 90° /down 90°

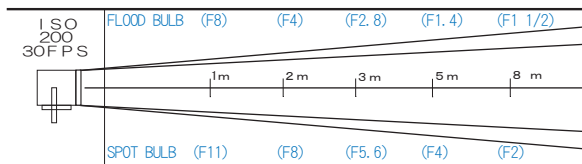

- Light Dimension 165mm (W) × 280mm (H) × 350mm (D)
- Weight 2kg ● Lens Diameter 100mm ● Spigot 17φ
- Input Power 100V
- Bulb 500w (Narrow · Very Narrow · Medium) 300w (Narrow · Medium)

PAR36 Short (Black or Silver)

RENTAL FEE ¥ 1,500

2P

max/up 90° /down 90°

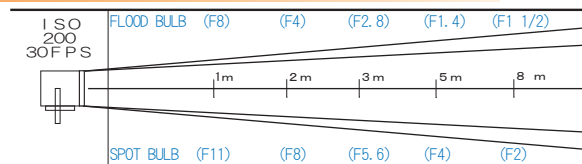

- Light Dimension 165mm (W) × 280mm (H) × 230mm (D)
- Weight 1kg ● Lens Diameter 100mm ● Spigot 17φ
- Input Power 100V
- Bulb 500w (Narrow · Very Narrow · Medium) 300w (Narrow · Medium)

※ Rental Fee doesn't include tax.

PAR16 (Black or Silver)

RENTAL FEE ¥1,000

2P

max/up 90° /down 90°

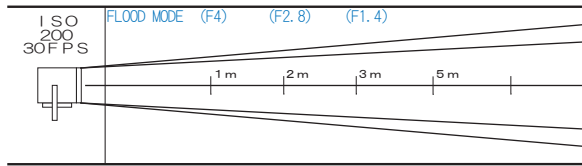

- Dimension 110mm (W) × 120mm (H) × 135mm (D)
- Weight 0.2kg ● Lens Diameter 55mm ● Spigot 17φ
- Input Power 100V

DEDOLIGHT (650w)

RENTAL FEE ¥8,000

2P

max/up 60° /down 60°

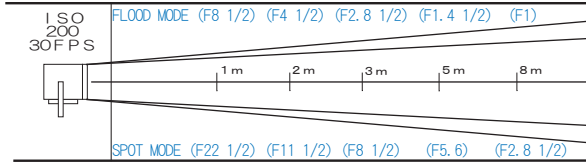

- Dimension 220mm (W) × 430mm (H) × 270mm (D) (Except Barndoor)
- Weight 3.9kg ● Spigot 25φ
- Including Projection attachment. ● Input Power 100V

ACCESSORIES

- Including Projection attachment. Cutter and Iris

DEDOLIGHT (150w)

RENTAL FEE ¥3,000

2P

max/up 60° /down 60°

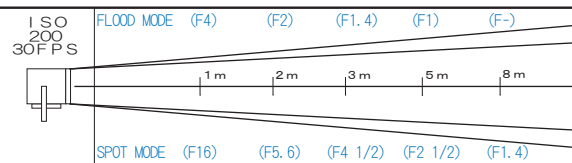

- Dimension 70mm (W) × 120mm (H) × 175mm (D) (Except Barndoor)
- Weight 1.5kg ● Lens Diameter 60mm ● Spigot 17φ
- Including Iris Lens · Cutter Lens ● Input Power 100V

ACCESSORIES



(Non-step dimming available.)

Note: Rented by single unit. ※ Dedolight can not be used for DC.

SOURCE FOUR 26° 575w/750w

RENTAL FEE ¥6,000

2P

max/up 90° /down 90°

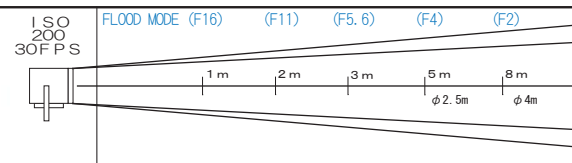

- Dimension 260mm (W) × 350mm (H) × 510mm (D)
- Weight 7kg ● Lens Diameter 110mm ● Spigot 17φ
- Input Power 100V

ACCESSORIES

- Lens (extra charge)
- 10° ¥5,000
- 19° ¥3,000
- 36° ¥3,000
- 50° ¥3,000

※Please see Page 64 for SOURCE FOUR ACCESSORIES.

SOURCE FOUR ZOOM 575w

RENTAL FEE ¥7,000

2P

max/up 60° /down 60°

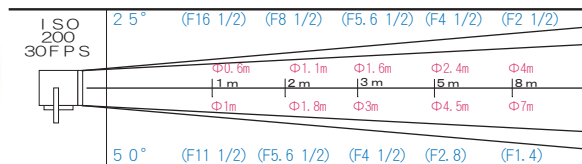

- Dimension 270mm (W) × 420mm (H) × 600mm (D)
- Weight 9kg ● Lens Diameter 130mm ● Spigot 17φ
- Input Power 100V ● Lens 2.5° ~ 5.0° variable

※ Rental Fee doesn't include tax.

SOURCE FOUR Mini Black or White or Silver **2P** max/up 90° /down 60°
 RENTAL FEE ¥2,000

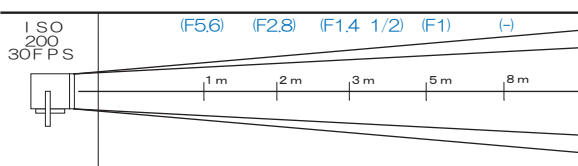

- Dimension 133mm (W) × 185mm (H) × 246mm (D)
- Weight 1.2kg ● Spigot 17φ ● Input Power 100V

500w ELLI SPOT **2P** max/up 60° /down 60°
 RENTAL FEE ¥2,000

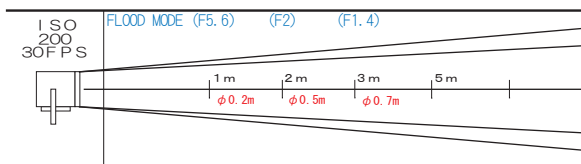

- Dimension 155mm (W) × 350mm (H) × 295mm (D)
- Weight 1.5kg ● Lens Diameter 38mm ● Spigot 17φ
- Including Mat x 4 · Cutter ● Input Power 100V

2kw PIN SPOT **C30A** max/up 60° /down 60°
 RENTAL FEE ¥10,000

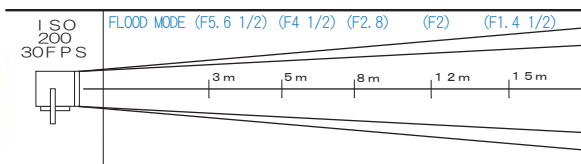

- Dimension 310mm (W) × 350mm (H) × 1080mm (D)
- Weight 24kg ● Lens Diameter 130mm ● Spigot 25φ
- Input Power 100V

ACCESSORIES

Disc machine



¥5,000

1kw PIN SPOT **2P** max/up 60° /down 60°
 RENTAL FEE ¥5,000

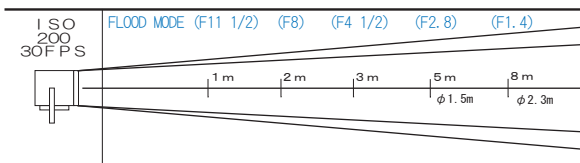

- Dimension 280mm (W) × 470mm (H) × 580mm (D)
- Weight 11kg ● Lens Diameter 165mm ● Spigot 17φ
- Including Iris ● Input Power 100V

STICK UP KIT 100w **2P**
 RENTAL FEE ¥6,000

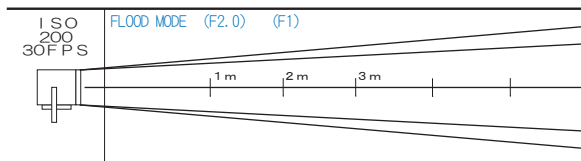

- Dimension 78mm (W) × 77mm (H) × 77mm (D)
- Weight 0.1kg ● Input Power 100V

3 Lights set

※ Rental Fee doesn't include tax.

BRACKET

RENTAL FEE ¥800

2P

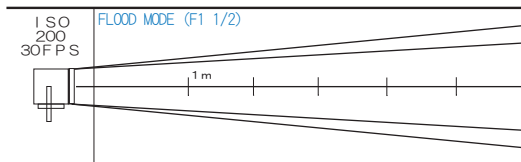

- Dimension 60mm (W) × 170mm (H) × 60mm (D)
- Weight 0.5kg ● Spigot 17φ ● Input Power 100V

Dichroic Reflector Halogen Lamp 150w (MR-16)

RENTAL FEE ¥800

2P

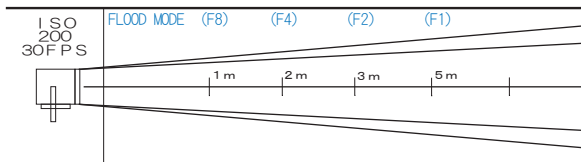

- Dimension 55mm (W) × 120mm (H) × 120mm (D)
- Weight 0.5kg ● Lens Diameter 55mm ● Input Power 100V

RING LIGHT L/S

RENTAL FEE ¥1,000

2P

(Excluding bulb charge)

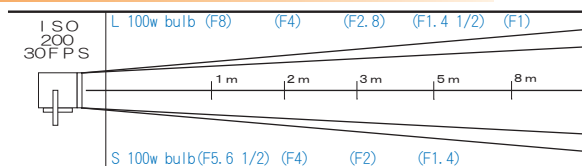

- Dimension L 1,130mm (W) × 1,130mm (H) × 255mm (D)
- Dimension S 890mm (W) × 890mm (H) × 255mm (D)
- Weight L 11kg S 7.5kg ● Input Power 100V

OCTOPUS RING LIGHT

RENTAL FEE ¥2,800

2P

(Excluding bulb charge)

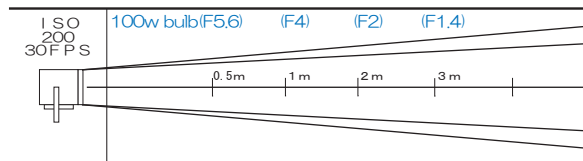

- Dimension 1,010mm (W) × 1,010mm (H) × 140mm (D)
- Weight 4.5kg ● Spigot 17φ ● Input Power 100V
- w/rod holder



Porcelain socket is adjustable. You can change tilt and length.



SUPER RING LIGHT

RENTAL FEE ¥2,000

2P

(Excluding bulb charge)

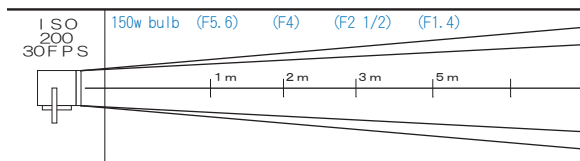

- Dimension 430mm (W) × 140mm (H) × 430mm (D)
- Weight 2.8kg ● Input Power 100V
- Available for 16mm/35mm Camera Lens Rod.
- w/rod holder

ACCESSORIES



Porcelain socket is adjustable. You can change tilt.

※ Rental Fee doesn't include tax.

DICHRONIC RING LIGHT RENTAL FEE ¥2,500 (Excluding bulb charge) **2P**

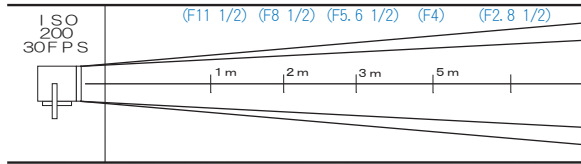

- Dimension 430mm (W) × 430mm (H) × 140mm (D)
- Weight 2.8kg ● Input Power 100V
- Available for 16mm/35mm Camera Lens Rod.

ACCESSORIES

- Dichroic bulb ¥1,000

KRYPTON RING LIGHT RENTAL FEE ¥1,000 (Excluding bulb charge) **2P**

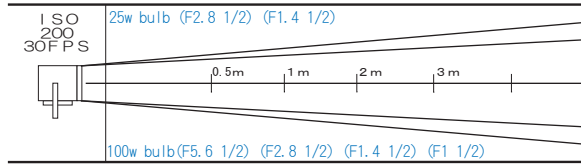

- Dimension 310mm (W) × 310mm (H) × 135mm (D)
- Weight 1.2kg ● Input Power 100V
- Available for 16mm/35mm Camera Lens Rod.

KRYPTON 36 RENTAL FEE ¥3,000 (Excluding bulb charge) **2P**

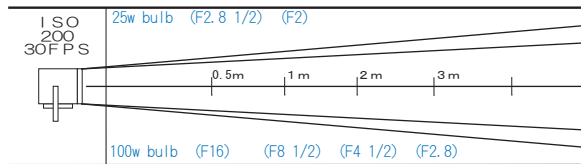

- Dimension 690mm (W) × 680mm (H) × 140mm (D)
- Weight 13kg ● Spigot 17φ ● Input Power 100V

INTERIOR LAMP SET RENTAL FEE ¥3,000 **2P**



- Dimension 650mm (W) × 140mm (H) × 45mm (D)
- Weight 1.5kg ● Spigot 17φ ● Input Power 100V

- 100w bulb Length 420mm × 4
- 60w bulb Length 250mm × 2
- 40w bulb Length 170mm × 2

LIGHT FOR CONSTRUCTION

2P

DEFERRED TYPE ¥500



- Input Power 100V

PENDANT TYPE ¥500

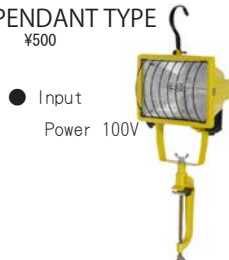

- Input Power 100V

STANDTYPE ¥800

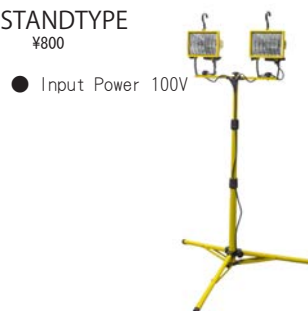

- Input Power 100V

NIGHT LIGHT EYELAMP ¥500



- Input Power 100V
- Spigot 17φ

※ Rental Fee doesn't include tax.

RAIL LIGHT



001 (BLACK)



001 (WHITE)



002 (BLACK)



002 (WHITE)



003 (WHITE)



004 (BLACK)



005 (BLACK)



005 (WHITE)



006 (SILVER)



006 (BLACK)



1 set
¥2,000

007 (WHITE)



1 set
¥2,000

007 (BLACK)

103w Twin square fluorescent tube
(Warm Whiter / Cool White / Daylight)



BUTTERFLY STRAIGHT

		Blub	Input	
BUTTERFLY STRAIGHT (E26)	12ft	10	2P x 10	¥2,000
BUTTERFLY STRAIGHT (E26)	9ft	17	2P x 17	¥2,000
		17	C60 x 2	¥2,000
		7	2P x 7	¥2,000
BUTTERFLY STRAIGHT (E26)	6ft	5	2P x 5	¥1,500
BUTTERFLY STRAIGHT (E17)	12ft	32	2P x 32	¥2,000
BUTTERFLY STRAIGHT (E17)	9ft	24	2P x 24	¥1,000
BUTTERFLY STRAIGHT (E17)	6ft	15	2P x 15	¥1,000

※ Rental Fee doesn't include tax.

RICE BULB

2P



RICE BULB STRING
¥2,000



RICE BULB ROPE
¥2,000



LED RICE BULB STRING
Each color ¥2,000

- White
- Red
- Green
- Blue
- Lemon Gold
- Orange

EYE LAMP / KRYPTON BULB

※Tube type is LED only (white / amber)



- EYE LAMP CORD (E26) ¥300
- EYE LAMP HOOD L / S ¥100
- EYE LAMP CAGE ¥100
- EYE LAMP PENDANT CORD (E26) ¥1,000



- KRYPTON 1BULB CORD (E17) ¥300
- KRYPTON PENDANT CORD (E17) ¥1,000
- E11 1BULB CORD ¥300

EYE LAMP

- 500w FLOOD / SPOT ¥600
- 300w FLOOD / SPOT ¥500
- 150w FLOOD / SPOT ¥400



BALL BULB

- 100w Frosted ¥200
- 60w Frosted ¥200
- 40w Frosted ¥200



HOUSEHOLD BULB

- 200w Frosted ¥200
- 150w Frosted ¥200
- 100w Frosted / Clear ¥100
- 80w Frosted / Clear ¥100
- 60w Frosted / Clear ¥100
- 40w Frosted / Clear ¥100
- 20w Frosted / Clear ¥100
- 60w Colored bulb R / G / B / Y ¥200



KRYPTON BULB

- 100w Frosted / Clear ¥100
- 60w Frosted / Clear ¥100
- 40w Frosted / Clear ¥100
- 25w Frosted / Clear ¥100



DICHROIC HALOGEN BULB

- 150w 10° ¥1,000
- 100w /75w each 10° / 20° / 35° ¥1,000



DICHROIC HALOGEN BULB SET

- 100w 70Φ 10 each of 10° / 20° / 35° (10 cables included) ¥10,000
- 100w 50Φ 6 each of 10° / 20° / 35° (5 cables included) ¥10,000
- 75w 50Φ 6 each of 10° / 20° / 35° (5 cables included) ¥10,000



HOUSEHOLD BULB / KRYPTON BULBET



- HOUSEHOLD BULB SET 20w/40w/60w/80w/100w (Frosted or Clear) each 10bulbs set ¥5,000

- KRYPTON BULB SET 25w/40w/60w/100w (Frosted or Clear) each 10bulbs set ¥5,000



- HOUSEHOLD COLORED BULB 60w R / G / B / Y each 10bulbs set (Frosted or Clear) ¥5,000

※ Rental Fee doesn't include tax.

EYELAMP FOCUSING LIGHT

Black or Silver

2P

RENTAL FEE ¥1,000 (Excluding bulb charge)

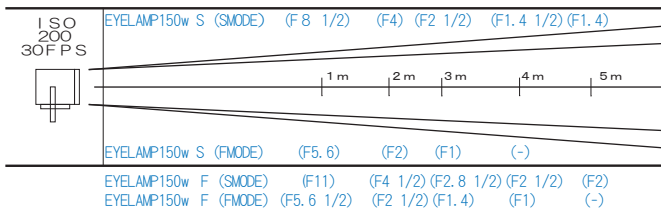

- Dimension 270mm (W) × 335mm (D)
- Weight 0.9kg
- Input Power 100V
- Socket E26 (up to 150w)

RADIO CONTROLLED LIGHT

RENTAL FEE ¥15,000

2P



Battery / Receiver



10w 20w 35w

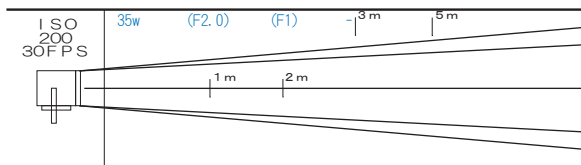

- Dimension 20Φ (W) × 45mm (H)
- Weight 0.2kg
- Input Power 12V



Controller

LOFT PENDANT LIGHT

RENTAL FEE ¥1,000

2P

(Excluding bulb charge)



BLACK



WHITE



SILVER

- Dimension 400mm (W) × 400mm (H) × 450mm (D)
- Weight 1kg
- Input Power 100V
- Socket E26 (up to 500w)

SPINNER 300w

RENTAL FEE ¥4,000

2P

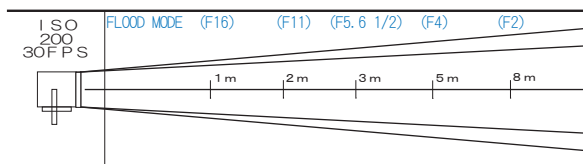

- Dimension 160mm (W) × 560mm (H) × 162mm (D)
- Weight 7kg
- Lens Diameter 155mm
- Spigot 17φ
- Input Power 100V
- 360° Rotatable (with Speed Controller)
- Including Cutter

※Example



COLOR BALL

RENTAL FEE ¥3,000



- Dimension 200mm (W) × 240mm (H)
- Weight 1.6kg
- Spigot 17φ
- Input Power 100V

RAINBOW LIGHT

RENTAL FEE ¥10,000



- Dimension 260mm (W) × 370mm (H) × 260mm (D)
- Weight 4.5kg
- Spigot 17φ
- Input Power 100v

GUARD LIGHT

RENTAL FEE ¥6,000

2P



- Dimension 160mm (W) × 250mm (H) × 175mm (D)
- Weight 2.5kg
- Spigot 17φ
- Input Power 100V
- Cover color Yellow / Red / Blue / Green
- 2P x 2 (For lighting and rotation.)

TUNGSTEN

※ Rental Fee doesn't include tax.

6ft 16BANK

RENTAL FEE ¥36,000

2P

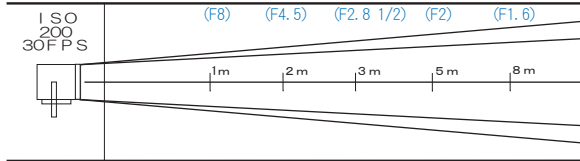

- Dimension 2,032mm (W) × 267mm (H) × 2,032mm (D)
- Weight 27.3kg
- Ballast Dimension 235mm (W) × 64mm (H) × 330mm (D)
- Ballast Weight 2.5kg × 4台 ● Light Cable Length 7.5m
- Input Power 100V /23A

ACCESSORIES

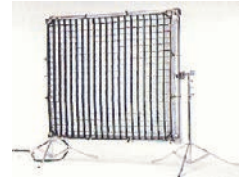

- Louver (Egg Crate) ¥10,000

8ft 4BANK

RENTAL FEE ¥22,000

2P

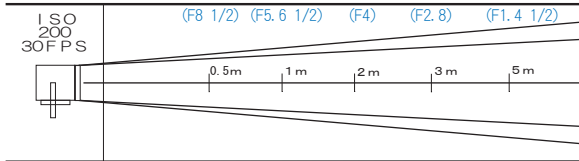

- Dimension 2,460mm (W) × 420mm (H) × 95mm (D)
- Weight 9kg ● Spigot 25φ
- Ballast Dimension 235mm (W) × 64mm (H) × 330mm (D)
- Ballast Weight 2.5kg ● Light Cable Length 7.5m ● Input Power 100V /7.2A

ACCESSORIES

- Louver ¥1,500



8ft 2BANK

RENTAL FEE ¥12,000

2P

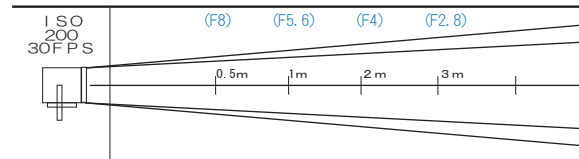

- Dimension 2,460mm (W) × 210mm (H) × 95mm (D)
- Weight 5.6kg ● Spigot 25φ
- Ballast Dimension 210mm (W) × 65mm (H) × 225mm (D)
- Ballast Weight 1.6kg ● Light Cable Length 7.5m ● Input Power 100V /4.5A

ACCESSORIES

- Louver ¥1,200



8ft 1BANK

RENTAL FEE ¥5,000

2P

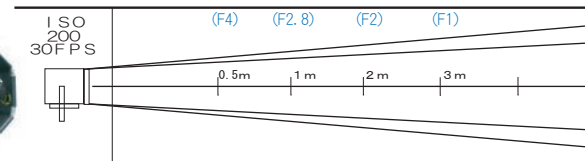

- Dimension 2,470mm (W) × 114mm (H) × 89mm (D)
- Weight 4kg ● Spigot 25φ
- Ballast Dimension 260mm (W) × 54mm (H) × 64mm (D)
- Ballast Weight 0.9kg ● Light Cable Length 7.5m ● Input Power 100V /2.6A

ACCESSORIES

- Louver ¥1,000



6ft 4BANK

RENTAL FEE ¥22,000

2P

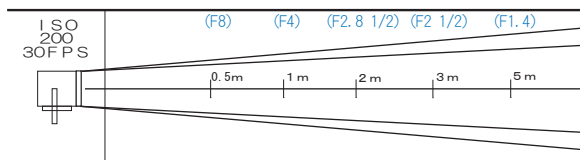

- Dimension 1,860mm (W) × 420mm (H) × 75mm (D)
- Weight 7.5kg ● Spigot 25φ
- Ballast Dimension 235mm (W) × 64mm (H) × 330mm (D)
- Ballast Weight 2.5kg ● Light Cable Length 7.5m ● Input Power 100V /6.2A

ACCESSORIES

- Louver ¥1,500



※ Rental Fee doesn't include tax.

6ft 2BANK

RENTAL FEE ¥12,000 **2P**

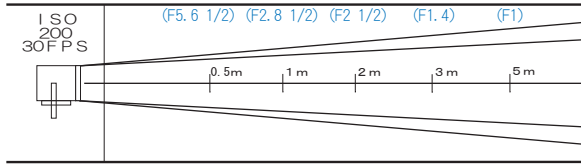

- Dimension 1,860mm (W) × 210mm (H) × 75mm (D)
- Weight 4.4kg ● Spigot 25φ
- Ballast Dimension 210mm (W) × 65mm (H) × 225mm (D)
- Ballast Weight 1.6kg ● Light Cable Length 7.5m ● Input Power 100V /3.7A

ACCESSORIES

- Louver ¥1,200



6ft 1BANK

RENTAL FEE ¥5,000 **2P**

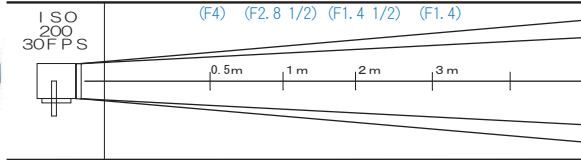

- Dimension 1,860mm (W) × 114mm (H) × 89mm (D)
- Weight 3.5kg ● Spigot 25φ
- Ballast Dimension 260mm (W) × 54mm (H) × 64mm (D)
- Ballast Weight 0.9kg ● Light Cable Length 7.5m ● Input Power 100V /1.9A

ACCESSORIES

- Louver ¥1,000



4ft 8BANK FLAT HEAD

RENTAL FEE ¥10,000 **2P**

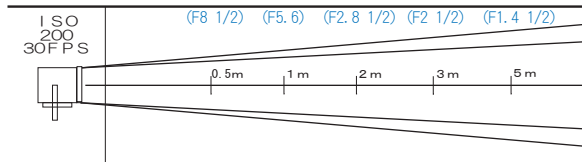

- Dimension 1,285mm (W) × 615mm (H) × 140mm (D)
- Weight 8.8kg ● Spigot 25φ
- Ballast Dimension 235mm (W) × 65mm (H) × 330mm (D)
- Ballast Weight 2.5kg×2 ● Light Cable Length 7.5m ● Input Power 100V /10A

ACCESSORIES

- Louver ¥1,000



4ft 8BANK (IMAGE85)

RENTAL FEE ¥8,000 **2P**

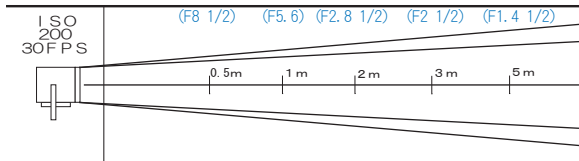

- Dimension 1,380mm (W) × 825mm (H) × 155mm (D)
- Weight w/Louver:17.6kg w/o Louver:16.2kg ● Spigot 25φ
- Input Power 100/200V (Automatically Switching) /12A
- DMX control System

ACCESSORIES

- Louver ¥1,000

4ft 4BANK (IMAGE45)

RENTAL FEE ¥6,000 **2P**

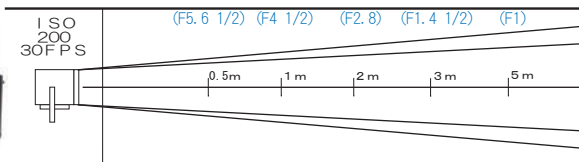

- Dimension 1,380mm (W) × 430mm (H) × 110mm (D)
- Weight 7kg ● Spigot 17φ
- Input Power 100/200V (Automatically Switching) /6A
- DMX control System

ACCESSORIES

- Louver ¥500

※ Rental Fee doesn't include tax.

TEGRA 4BANK

RENTAL FEE ¥ 6,000

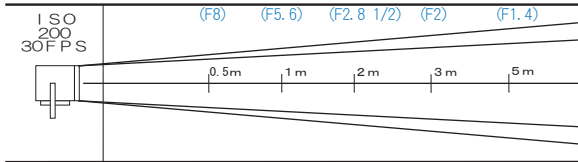

- Dimension 1,320mm (W) × 340mm (H) × 150mm (D)
- Weight 8.4kg ● Spigot 25φ
- Input Power 100/200V (Automatically Switching) /2.8A

ACCESSORIES

- Including Louver

4ft 4BANK

RENTAL FEE ¥ 6,000

2P

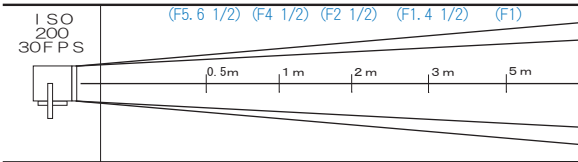

- Dimension 1,310mm (W) × 325mm (H) × 250mm (D)
- Weight 4.5kg
- Ballast Dimension 210mm (W) × 65mm (H) × 315mm (D)
- Ballast Weight 2kg ● Light Cable Length 7.7m ● Input Power 100V /6A

ACCESSORIES

- Louver ¥500



4ft 2BANK

RENTAL FEE ¥ 5,000

2P

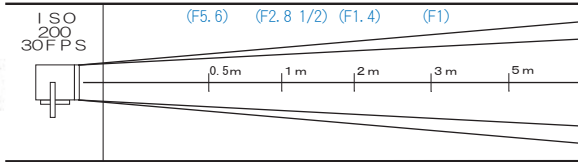

- Dimension 1,310mm (W) × 180mm (H) × 250mm (D)
- Weight 3kg
- Ballast Dimension 210mm (W) × 65mm (H) × 210mm (D)
- Ballast Weight 1kg ● Light Cable Length 7.7m ● Input Power 100V /3.1A

ACCESSORIES

- Louver ¥500



4ft 1BANK

RENTAL FEE ¥ 2,000

2P

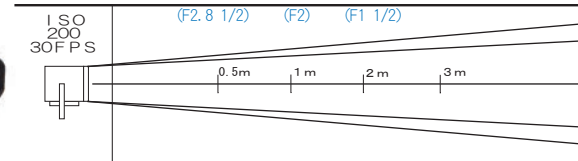

- Dimension 1,310mm (W) × 100mm (H) × 250mm (D)
- Weight 2kg
- Ballast Dimension 57mm (W) × 63mm (H) × 260mm (D)
- Weight 0.5kg ● Light Cable Length 7.7m ● Input Power 100V /1.5A

ACCESSORIES

- Louver ¥500



2ft 4BANK

RENTAL FEE ¥ 6,000

2P

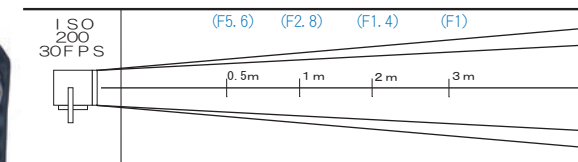

- Dimension 680mm (W) × 325mm (H) × 250mm (D)
- Weight 4kg
- Ballast Dimension 210mm (W) × 65mm (H) × 315mm (D)
- Weight 2kg ● Light Cable Length 7.7m ● Input Power 100V /3A

ACCESSORIES

- Louver ¥500



※ Rental Fee doesn't include tax.

2ft 2BANK

RENTAL FEE ¥4,000

2P

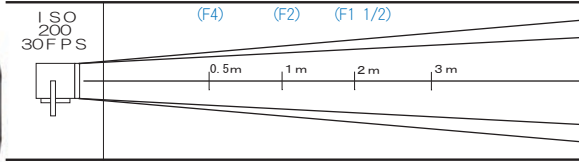

- Dimension 680mm (W) × 180mm (H) × 250mm (D)
- Weight 2kg
- Ballast Dimension 210mm (W) × 65mm (H) × 210mm (D)
- Weight 1kg ● Light Cable Length 7.7m
- Input Power 100/200V (Automatically Switching) /1.6A

ACCESSORIES

- Louver ¥500



2ft 1BANK

RENTAL FEE ¥2,000

2P

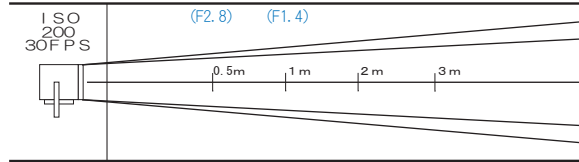

- Dimension 680mm (W) × 110mm (H) × 250mm (D)
- Weight 1.5kg
- Ballast Dimension 57mm (W) × 63mm (H) × 260mm (D)
- Weight 0.5kg ● Light Cable Length 7.7m
- Input Power 100/200V (Automatically Switching) /0.95A

ACCESSORIES

- Louver ¥200



VistaBeam600

RENTAL FEE ¥10,000

2P

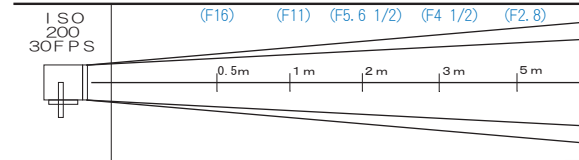

- Dimension 1,000mm (W) × 1,140mm (H) × 200mm (D)
- Weight 21.2kg ● Spigot 25φ
- Input Power 100V /11A

※When exchanging lamp, please be careful about Pin breaking.
Please be careful not to cut hand by side cover edge.

ACCESSORIES

- Louver ¥1,000



Backside

DMX Control

VistaSingle

2 Lights set RENTAL FEE ¥5,000

2P



2 Lights set

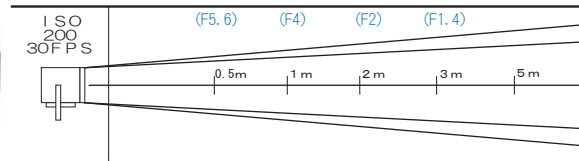

- Dimension 975mm (W) × 115mm (H) × 180mm (D)
- Weight 2.85kg
- Ballast Dimension 104mm (W) × 67mm (H) × 252mm (D)
- Weight 1.24kg ● Input Power 100V /2A

ACCESSORIES

- Louver ¥500



ParaBeam

RENTAL FEE ¥8,000

2P

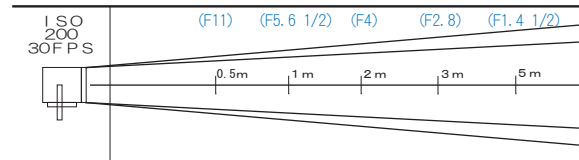

- Dimension 610mm (W) × 610mm (H) × 155mm (D)
- Weight 6kg ● Spigot 25φ
- Input Power 100V /2.1A

ACCESSORIES

- Louver ¥1,000



Backside

DMX Control

※ Rental Fee doesn't include tax.

DIVA-LITE 400

RENTAL FEE ¥10,000

2P

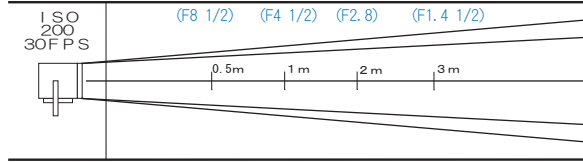

- Dimension 660mm (W) × 290mm (H) × 140mm (D)
- Weight 6.6kg ● Mount
- Input Power 100/200V(automatically switching) /2.28A

ACCESSORIES

- Including Louver and Diffuser

DIVA-LITE 200

RENTAL FEE ¥8,000

2P

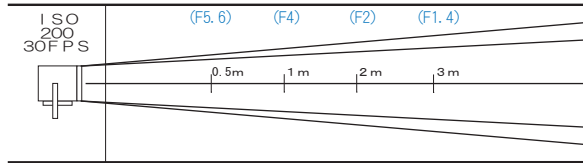

- Dimension 650mm (W) × 200mm (H) × 140mm (D)
- Weight 3.4kg ● Mount
- Input Power 100V /1.4A

ACCESSORIES

- Including Louver and Diffuser

BarFly400

RENTAL FEE ¥8,000

2P

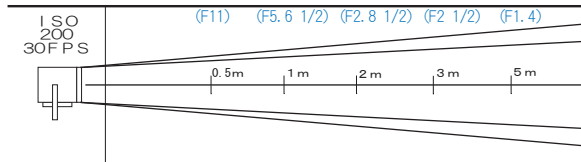

- Dimension 435mm (W) × 440mm (H) × 60mm (D)
- Weight 3.27kg
- Ballast Dimension 235mm (W) × 65mm (H) × 345mm (D)
- Weight 2.72kg ● Input Power 100V /4.2A

ACCESSORIES



BarFly200

RENTAL FEE ¥6,000

2P

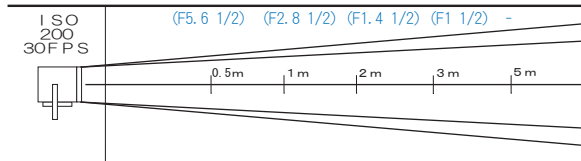

- Dimension 230mm (W) × 440mm (H) × 65mm (D)
- Weight 2.52kg
- Ballast Dimension 235mm (W) × 65mm (H) × 245mm (D)
- Weight 1.6kg ● Input Power 100V /2.1A

ACCESSORIES



12v SINGLE KIT

RENTAL FEE ¥6,000

2P



- Dimension 440mm (W) × 95mm (H) × 75mm (D)
- Weight 0.5kg
- Ballast Dimension 130mm(W) × 55mm(H) × 290mm(D)
- Ballast Weight 1.5kg
- Dimming available
- D/T bulb x 2 set
- Input Power 100V /DC12V

MINI FLO KIT

RENTAL FEE ¥3,000

2P



- Dimension 264mm (W) × 30mm (H) × 80mm (D)
- Weight 0.2kg
- Dimming available
- D/T bulb x 2 set
- Input Power 100V /DC12V

※ Rental Fee doesn't include tax.

MICRO FLO KIT

RENTAL FEE ¥5,000 **2P**



- Light Dimension 25mm (W) × 20mm (H) × 110mm (D)
- Weight 0.1kg
- D/T bulb x 2 set
- Input Power 100V / D C 12V

FL RING LIGHT

RENTAL FEE ¥4,000 **2P**



- Dimension 310mm (W) × 310mm (H) × 90mm (D)
- Weight 1kg
- Ballast Dimension 57mm (W) × 63mm (H) × 260mm (D)
- Weight 0.5kg
- Input Power 100v
- Available for 16mm/35mm camera lens rod.
- 40W, 32W, 30W bulbs available.

KAMIO

RENTAL FEE ¥15,000 **2P**

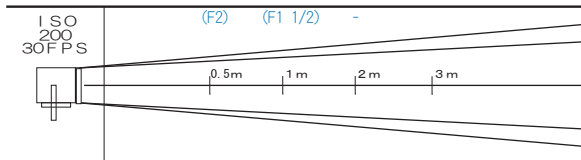

- Light Dimension 255mm (W) × 230mm (H) × 65mm (D)
- Light Weight 0.5kg
- Ballast Dimension 120mm (H) × 51mm (H) × 65mm (D)
- Ballast Weight 0.4kg ● Input Power 100V / 7A
- Lens Adapter 80mm · 85mm · 87mm · 95mm · 98mm · 102mm · 104mm · 110mm

FL LOCATION KIT

RENTAL FEE ¥3,000 **2P**

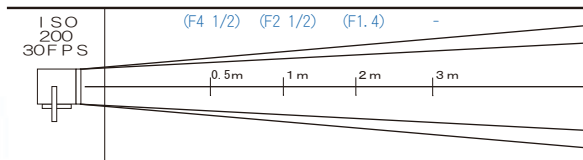

- Light Dimension 348mm (W) × 125mm (高さ) × 85mm (D)
- Weight 6.6kg
- Input Power 100V / 5A · 24V

ACCESSORIES



KINO DIVA STREET LAMP

RENTAL FEE (1lamp) ¥2,000 **2P**

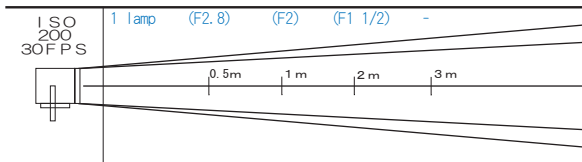

- Light Dimension 130mm (W) × 560mm (H) × 900mm (D)
- Light Weight 3.2kg
- Input Power 1bulb 100V / 1A



KINO FLO LINEUP

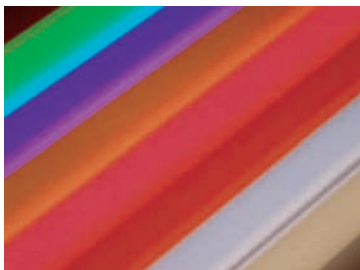

- 2900K A lamp
- 3200K T lamp
- 5500K D lamp
- Colored lamp
- Red · Green
- Blue · Yellow
- Pink
- Rainbow Sleeve

FL HOLDER

RENTAL FEE ¥400



※ Rental Fee doesn't include tax.

KINO FLO CURVED FRAME RENTAL FEE ¥1,500



- Dimension 1,030mm (W) × 900mm (H) × 260mm (D)
- 20w Kino Flo tube × 8 installable
- Excluding KINO FLO tube.

KINO FLO HARNESS SET



- 20W 1BANK ¥2,000 (Length 61cm)
- 40W 1BANK ¥2,000 (Length 123cm)
- 85W 1BANK ¥5,000 (Length 179cm)
- 110W 1BANK ¥5,000 (Length 240cm)

LED 1 x 1 FELLONI BICOLOR 2P RENTAL FEE ¥8,000

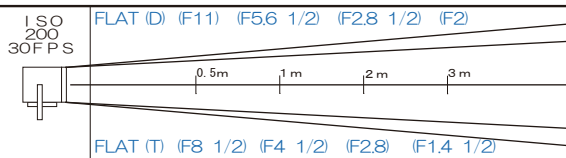

- Dimension 350mm (W) × 390mm (H) × 95mm (D)
- Weight 2kg ● Spigot 17Φ
- Input Power 100V~240V 0.5A
- V-mount Battery available (1hour 20minutes ~ 3hours 30minutes)
- Daylight & Tungsten Light controllable. Kelvin can be changed by using a rotary dial
- DMX Control System

ACCESSORY



Dimmer



included Chimera/ Egg crate/ Louver/ Diffuser

LED LITE PANELS 1 x 1 FLOOD / SPOT 2P RENTAL FEE ¥3,000

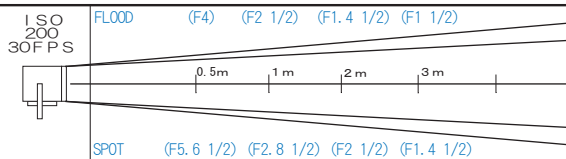

- Dimension 350mm (W) × 465mm (H) × 55mm (D)
- Weight 2kg ● Input Power 100V 0.5A

ACCESSORIES



1x1 V Mount Adapter
¥ 1,000

LED LITE PANELS BICOLOR 1 x 1 RENTAL FEE 2P ¥6,000

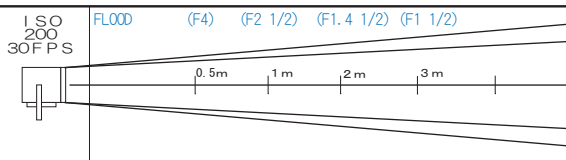

- Dimension 350mm (W) × 465mm (H) × 100mm (D)
- Weight 2kg ● Input Power 100V 0.5A
- DMX Control System(DMX Cable : optional ¥500)
- Daylight & Tungsten Light controllable.
- Kelvin can be changed by using a rotary dial

ACCESSORIES



Including Diffuser set and
1x1 V Mount Adapter.

LED LITEPANELS 2 x 2 RENTAL FEE ¥12,000 2P

※ Frame and bulb set

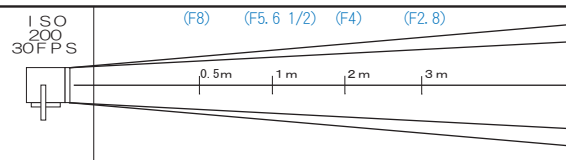

- Dimension 745mm (W) × 885mm (高さ) × 160mm (D)
- Weight 13kg ● Input Power 100V

※ Rental Fee doesn't include tax.

LED LITEPANELS 4 x 4

RENTAL FEE ¥48,000

2P

※ Frame and bulb set

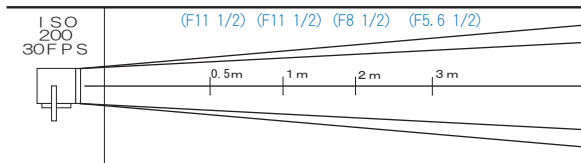

- Dimension 1,535mm (W) × 1,500mm (H) × 160mm (D)
- Weight 48kg ● Input Power 100W

LED SKYPANEL S120C

Full Color 2P
RENTAL FEE ¥32,000

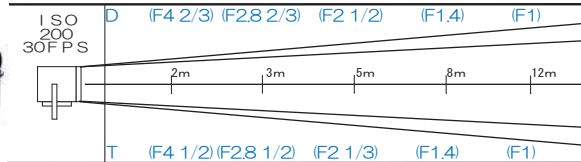

- Light Dimension 1394mm (W) × 473mm (H) × 223mm (D : Including Ballast)
133mm (D : Without Ballast)
- Weight (Light body) 14kg (Without Ballast) Ballast 10kg ● Spigot 28Φ
- Input Power 110~240V ● DMX control system ● Power consumption 400W (Normal) 、 430W (MAX)
- Dry fit Battery available (LB-380:60minutes、LB-H4:80minutes)

If you use in the LB-H4, you will need a dedicated code.
Please protect the fixture using appropriate cover because this is very sensitive to wet and dust.
The S120 can be operated at up to 50% of its total power while on battery.

ACCESSORY

- Including
 - Center Arm
 - Center Mount Yoke
 - Power Supply Unit
 - Mains Cables, powerCON TRUE1
 - DC Cable (0.5m/3m/10m)
 - H4 Conversion Cable
 - Louver

LED SKYPANEL S60C

2P
RENTAL FEE ¥25,000

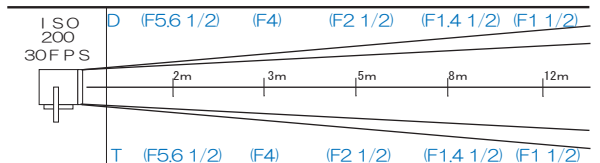

- Light Dimension 800mm (W) × 530mm (H) × 270mm (D : Including Ballast)
145mm (D : Without Ballast)
- Weight (Light body) 9.23kg (Without Ballast) Ballast 5kg ● Spigot 25Φ
- Input Power 90~250V ● DMX control system ● Power consumption 420W (Normal) 、 450W (MAX)
- Dry fit Battery available (LB-380:60minutes、LB-H4:80minutes)

If you use in the LB-H4, you will need a dedicated code.
Please protect the fixture using appropriate cover because this is very sensitive to wet and dust.
The S60 can be operated at up to 50% of its total power while on battery.

ACCESSORY

- Including
 - 4-leaf Barndoor S60
 - Center Arm
 - Center Mount Yoke
 - Power Supply Unit
 - Power Supply Unit Holder
 - Space Light Silk Mounting Adapter S60
 - Mains Cables, powerCON TRUE1
 - DC Cable (0.5m/3m/5m/10m)
 - Louver
 - Super Clamp Adapter for SkyPanel PSU

Light Cable Length

LED SKYPANEL S30C

Full Color 2P
RENTAL FEE ¥20,000

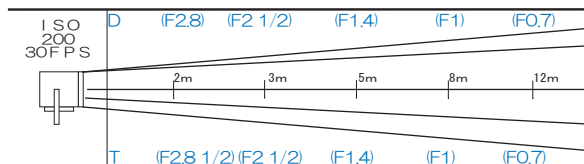

- Light Dimension 446mm (W) × 426mm (H) × 224mm (D : Including Ballast)
133mm (D : Without Ballast)
- Weight (Light body) 7.8kg (Without Ballast) Ballast 2.5kg ● Spigot 25Φ
- Input Power 90~250V ● DMX control system
- Power consumption 200W (Normal) 、 240W (MAX)
- Dry fit Battery available (LB-380:60minutes、LB-H4:80minutes)

If you use in the LB-H4, you will need a dedicated code.
Please protect the fixture using appropriate cover because this is very sensitive to wet and dust.
The S120 can be operated at up to 50% of its total power while on battery.

ACCESSORY

- 付属品
 - 4-leaf Barndoor S30
 - Center Arm
 - Center Mount Yoke
 - Power Supply Unit
 - Power Supply Unit Holder
 - Mains Cables, powerCON TRUE1
 - DC Cable (0.5m/3m/10m)
 - Louver
 - Super Clamp Adapter for SkyPanel PSU
 - H4 Conversion Cable

※ Rental Fee doesn't include tax.

LED Celeb 250

Full Color 2P
RENTAL FEE ¥15,000

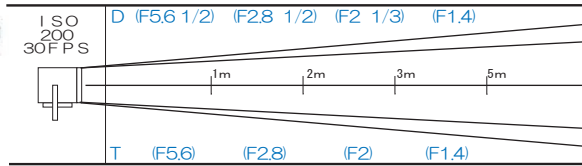

- Light Dimension 610mm (W) × 355mm (H) × 127mm (D)
- Weight 6.8kg ● Spigot 17Φ ● Input Power 100~240V 0.96A
- Dry fit Battery available ● DMX control system

ACCESSORY

- Including
- Honeycomb Grid
- AC cable

LED Celeb 450

Full Color 2P
RENTAL FEE ¥18,000

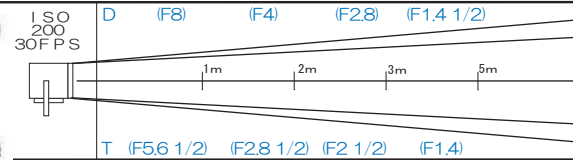

- Light Dimension 1145mm (W) × 355mm (H) × 160mm (D)
- Weight 12kg ● Spigot 25Φ ● Input Power 100~240V 2.16A
- DMX control system

ACCESSORY

- Including
- Honeycomb Grid
- AC cable

LED Celeb 450Q

Full Color 2P
RENTAL FEE ¥22,000

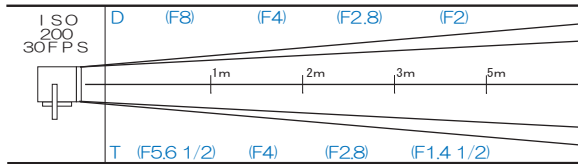

- Light Dimension 702mm (W) × 603mm (H) × 130mm (D)
- Weight 11kg ● Spigot 25Φ ● Input Power 100~240V 2.16A
- DMX control system

ACCESSORY

- 付属品
- Honeycomb Grid
- AC cable

KELVIN BOARD

RENTAL FEE ¥12,000 2P

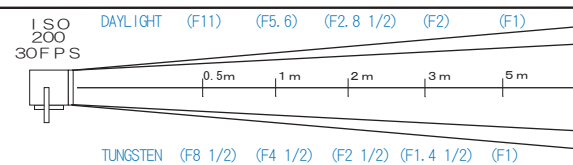

- Light Dimension 690mm (W) × 680mm (H) × 82mm (D)
- Weight 10kg ● Spigot 17Φ ● Input Power 100/200V 2A
- Dimmer available for Daylight and Tungsten. Color temperature can be changed by dial.

ACCESSORY



- 6ch Controller ¥3,000
- 2ch Controller
- Louver

LED LITE PANEL KIT

RENTAL FEE ¥6,000 2P

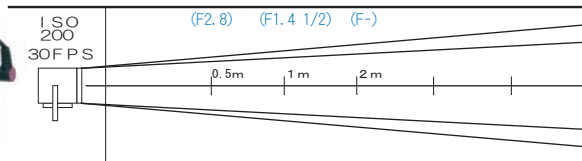

40 minutes available by battery

- Light Dimension 185mm (W) × 60mm (H) × 32mm (D)
- Battery Dimension (except pin) 175mm (W) × 60mm (H) × 20mm (D)
- Total Dimension 185mm (W) × 60mm (H) × 60mm (D)
- Light Weight 350g Battery Weight 450g Total Weight 800g
- AC Adapter Input Power 100/200V(Automatic switching)



2 lights set (with battery x 2)

LED HiLio D12

RENTAL FEE ¥ 8,000 **2P**

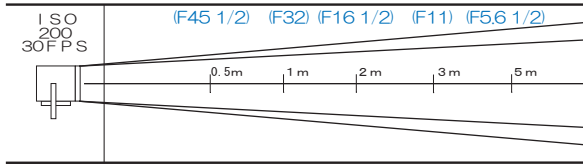

- Light Dimension 520mm (W) × 490mm (H) × 225mm (D)
- Weight 13.5kg ● Spigot 25Φ
- Input Power 100/200V(auto sensing) 3.4A
- DMX control system

- Including
- Filters

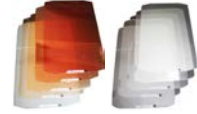

LED CINEROID 400 BICOLOR

RENTAL FEE ¥ 4,000 **2P**

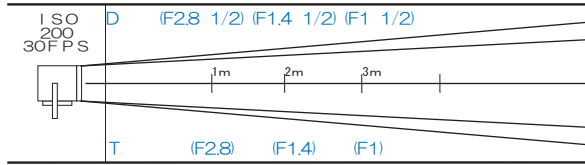

- Dimension 250mm (W) × 235mm (H) × 75mm (D) ● Weight 1.2kg ● Spigot 17Φ
- Input Power 100V~240V (50/60Hz) (1.6A) ● Output 16V ● V-mount Battery available (80 minutes)

ACCESSORY

- Including
- Filters (Diffusion x 2, Clear)
- AC Adapter
- Spigot

LED CINEROID 800 BICOLOR

RENTAL FEE ¥ 5,000 **2P**

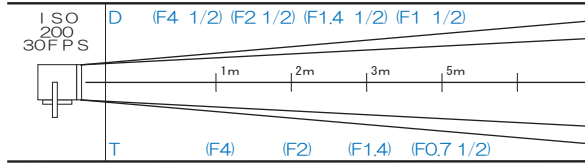

- Dimension 335mm (W) × 290mm (H) × 95mm (D) ● Weight 2.2kg ● Spigot 17Φ
- Input Power 90V~264V (50/60Hz) (3.5A) ● Output 35V ● V-mount Battery available (60 minutes)

ACCESSORY

- Including
- Filters (Clear)
- DC Cable
- AC Adapter
- Spigot

LED CINEROID 10 BICOLOR

RENTAL FEE ¥ 3,500 (for a set of two) **2P**

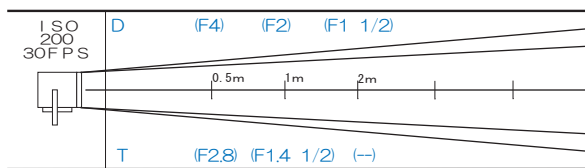

- Dimension 103mm (W) × 85mm (H) × 40mm (D) ● Weight 195g ● Spigot 17Φ
- Input Power 100V~240V (50/60Hz) (0.58A) ● Output 12V ● SONY NP-F970 Battery available (120 minutes)

ACCESSORY

- Including
- Filters (Diffusion, Clear, Grid)
- AC Adapter
- Spigot
- SONY NP-F970 Battery
- Camera Shoe Adapter

LED SELECT30

Full Color **2P**
RENTAL FEE ¥ 18,000

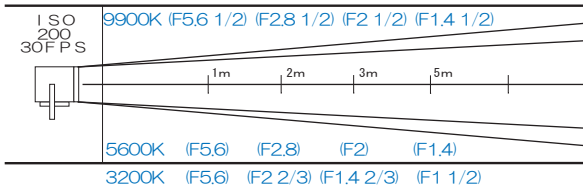

- Light Dimension 1020mm (W) × 220mm (H) × 100mm (D) ● Weight 5.0kg ● Spigot 25Φ
- Input Power 100V~240V (50/60Hz) ● DMX control system ● color temperature 2500~9900K
- Dry fit Battery available ● LED Full Color

ACCESSORY

- Including
- Controller
- Honeycomb Grid
- Diffuser
- DC Cable
- AC Adapter
- Spigot

※ Rental Fee doesn't include tax.

Free Style31

Full Color 2P
RENTAL FEE ¥18,000

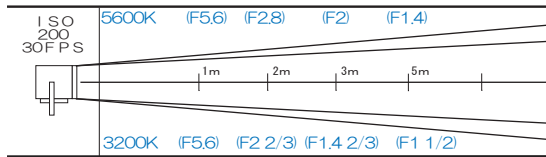

- Light Dimension 1030mm (W) × 280mm (H) × 90mm (D) ● Weight 7.0kg ● Spigot 17Φ
- Input Power 100V~240V (50/60Hz) ● DMX control system ● color temperature 2500~9900K
- Dry fit Battery available ● LED Full Color

Free Style21

Full Color 2P
RENTAL FEE ¥16,000

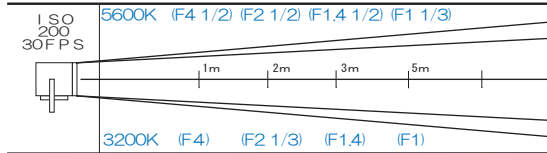

- Light Dimension 670mm (W) × 330mm (H) × 90mm (D) ● Weight 5.0kg ● Spigot 17Φ
- Input Power 100V~240V (50/60Hz) ● DMX control system ● color temperature 2500~9900K
- Dry fit Battery available ● LED Full Color

LED FOTODIOX 1500

2P
RENTAL FEE ¥10,000

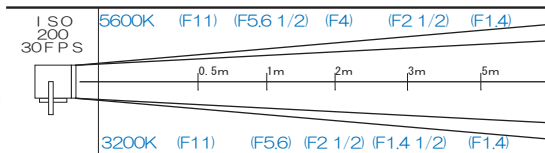

- Dimension 800mm (W) × 800mm (T) × 100mm (D) ● Weight 9.23kg ● Spigot 17Φ
- Input Power 100V~240V (50/60Hz) ● Include AC Adapter, DMX code, Spigot
- V-mount Battery available (with 2 batteries:約1.5hours)

LED FOTODIOX 300

2P
RENTAL FEE ¥4,000

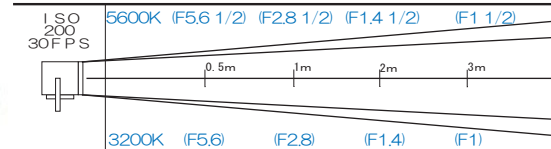

- Dimension 310mm (W) × 310mm (H) × 57mm (D : with Battery)
× 50mm (D : without Battery)
- Weight 742g ● Spigot 17Φ
- Input Power 100V~240V (50/60Hz) 0.3A
- Include AC Adapter (for lamp head) , Sony Battery×2, Battery Charger
AC Adapter (for Charger) , Cigarette socket (for Charger) , Spigot
- Sony Battery available (with 2 batteries:1.5hours)

LED FOTODIOX 318

2P
RENTAL FEE ¥4,000

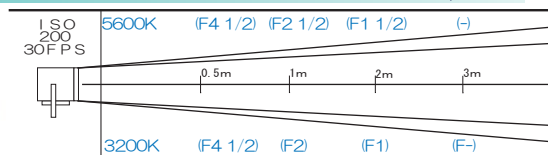

- Dimension 310mm (W) × 310mm (H) × 60mm (D : with Battery)
× 46mm (D : without Battery)
- Weight 850g ● Spigot 17Φ
- Input Power 100V~240V (50/60Hz) / DC 6V~18V 0.3A
- Include AC Adapter (for lamp head) , Sony Battery×2, Battery Charger
AC Adapter (for Charger) , Cigarette socket (for Charger) , Spigot
- Sony Battery available (with 2 batteries:1.5hours)

ACCESSORY

- Including
- Controller
- Honeycomb Grid
- DC Cable
- AC Adapter
- Spigot

ACCESSORY

- Including
- Controller
- Honeycomb Grid
- DC Cable
- AC Adapter
- Spigot

※ Rental Fee doesn't include tax.

LED FOTODIOX C-700

RENTAL FEE ¥ 6,000

2P

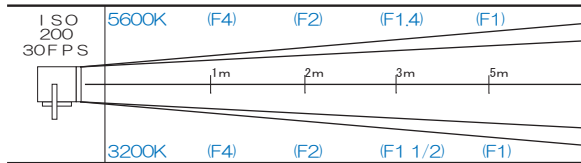

- Dimension 520mm (W) × 530mm (H) × 60mm (D : with Battery)
× 50mm (D : without Battery)
- Weight 2.85kg ● Spigot 17Φ
- Input Power 100V~240V (50/60Hz) / DC 15V 0.6A
- Include AC Adapter (for lamp head)、Sony Battery×2、Battery Charger
AC Adapter (for Charger)、Cigarette socket (for Charger)、Spigot
- Sony Battery available (with 2 batteries 1.3hours) ● V-mount Battery available

LED LINEAR PANEL

RENTAL FEE ¥ 8,000

2P

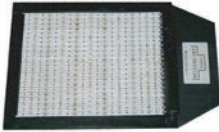

- Light Dimension 410mm (W) × 280mm (H)
× 22mm (D)
- Weight 500g



- Light Dimension 205mm (W) × 95mm (H)
× 18mm (D)
- Weight 150g

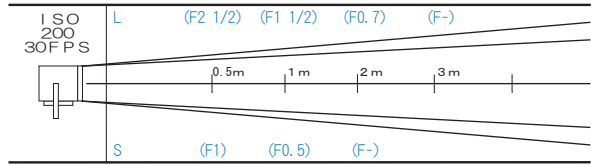

- Power Supply Dimension 160mm (W) × 110mm (H) × 290mm (D)
- Weight 1.8kg ● Light cable length 4.2m
- Input Power 100V

LED MICRO PRO

RENTAL FEE ¥ 2,000

ACCESSORY

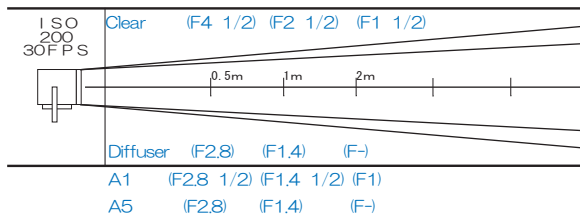

Filters
(Diffusion, A1, A5)

- Dimension 145mm (W) × 205mm (H) × 45mm (D) ● Weight 300g ● Spigot Φ17 ● Power consumption 0.09A
- 2A Battery ● Including Ball head, Screw Spigot, Filters (Diffuser, A1, A5), 2A Battery

LED MATRIX MULTI COLOR16

RENTAL FEE ¥ 8,000

2P

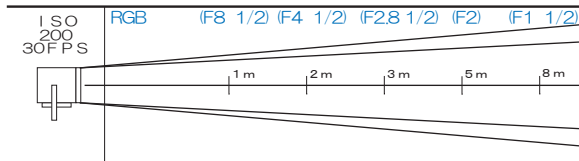

- Dimension 350mm (W) × 470mm (H) × 153mm (D) ● Weight 8.3kg ● Spigot 25Φ
- Input Power 100V~240V (50/60Hz) ● Various colors available based on RED/GREEN/BLUE
- DMX 512 ● Power consumption 5A

LED MATRIX MULTI COLOR8

RENTAL FEE ¥ 5,000

2P

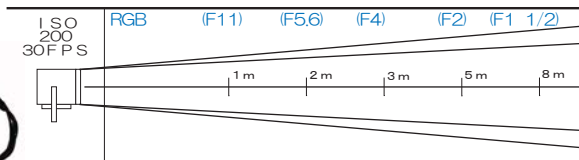

- Dimension 745mm (W) × 165mm (H) × 120mm (D)
- Weight 4.1kg ● Input Power 100~240V (50/60Hz)
- LED Color Red/Green/Blue
- DMX 512

LED

※ Rental Fee doesn't include tax.

LED BOXER

RENTAL FEE ¥ 6,000

2P

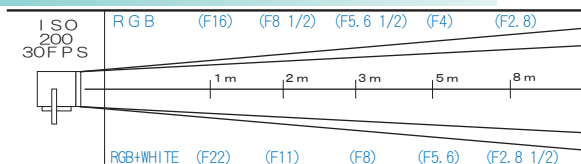

- Dimension 305mm (W) × 276mm (H) × 230mm (D)
- Weight 8.5kg ● Spigot 25φ ● Input Power 100/200V (Automatic switching) 0.2A
- LED color Red/Green/Blue/White LED bulb × 4 8
- DMX 5 1 2

LED SoLaENG

RENTAL FEE ¥ 5,000
(for a set of two)

2P

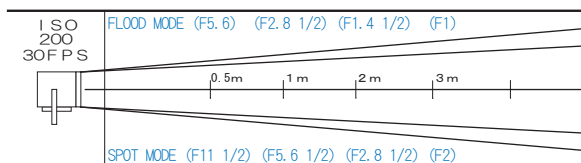

- Dimension 140mm (W) × 220mm (H) × 130mm (D)
- Weight 0.55kg ● Input Power 100V / DC14.4V 0.3A
- Accessories : AC Adapter, Camera Hotshoe Adapter

Grip Adapter, Stand Arm, Cable for V mount Battery, Filter, Barndoor

ACCESSORY



V-mount Grip
¥ 2,000

ARRI L5 Color

RENTAL FEE ¥ 8,000

2P

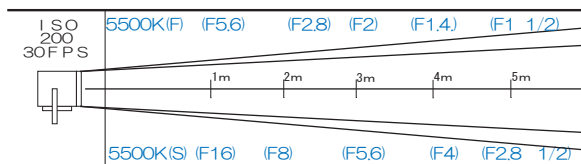

- Dimension 278mm (W) × 394mm (H) × 280mm (D) ● Weight 5.1kg ● Spigot 16-28φ
- Input Power 100V~250V (50/60Hz) / 1.15A (MAX 115w) ● Accessories: Barndoor
- Dry fit Battery available (2.5 hours) ● DMX control system

ARRI L7 Color

RENTAL FEE ¥ 12,000

2P

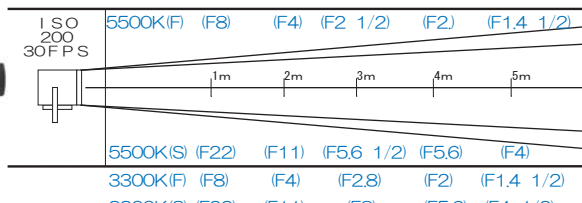

- Dimension 374mm (W) × 500mm (H) × 349mm (D) ● Weight 8.2kg ● Spigot 28φ ● Accessories: Barndoor
- Input Power 100V~250V (50/60Hz) / 2.5A (MAX 220w) ● DMX control system

ARRI L10 Color

RENTAL FEE ¥ 15,000

2P

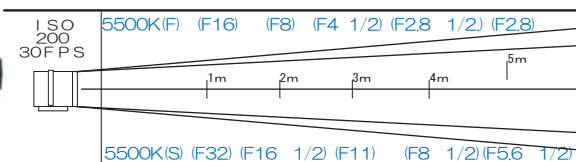

- Dimension 502mm (W) × 714mm (H) × 560mm (D) ● Weight 19.7kg ● Spigot 28φ
- Input Power 100V~250V (50/60Hz) / 5.1A (MAX 510w) ● Accessories: Barndoor
- DMX control system

※ Rental Fee doesn't include tax.

LED Fiilex P360

RENTAL FEE ¥6,000 (for a set of two) **2P**

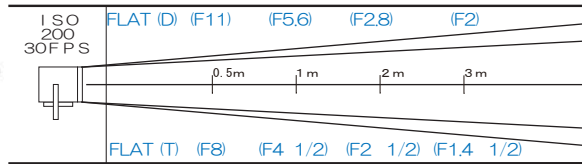

- Dimension 150mm (W) × 168mm (H) × 150mm (D)
- Weight 800g
- Spigot 17Φ
- Input Power 100V~240V 1.5A
- Power consumption 0.9A

Dimmer available for Daylight and Tungsten.
Color temperature can be changed by dial.

ACCESSORY

- Including
- Barndoor
- Frosted cup
- Fresnel lens
- Umbrella holder
- Chimera set
- AC Adapter
- Camera Shoe Adapter

LED Fiilex P180

RENTAL FEE ¥4,000 (for a set of two) **2P**

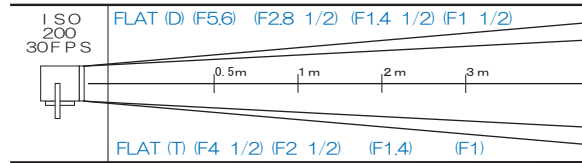

- Dimension 115mm (W) × 160mm (H) × 98mm (D)
- Weight 430g
- Spigot 17Φ
- Input Power 100V~240V 1.5A
- Power consumption 0.4A

Dimmer available for Daylight and Tungsten.
Color temperature can be changed by dial.

ACCESSORY

- Including
- Barndoor
- AC Adapter
- Camera Shoe Adapter

LED Sola9 (Daylight) / Inca9 (Tungsten)

RENTAL FEE ¥8,000 **2P**

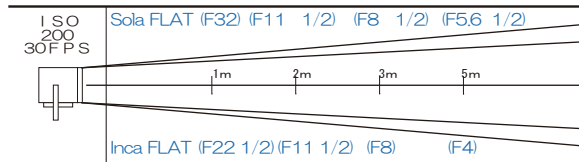

- Dimension 410mm (W) × 550mm (H) × 365mm (D)
- Weight 7.5kg
- Spigot 17Φ
- Input Power 100V~240V 1.9A
- DMX control system (DMX Cable : optional ¥500)

ACCESSORY

- Including
- Barndoor
- AC Adapter

LED Sola6 (Daylight) / Inca6 (Tungsten)

RENTAL FEE ¥6,000 **2P**

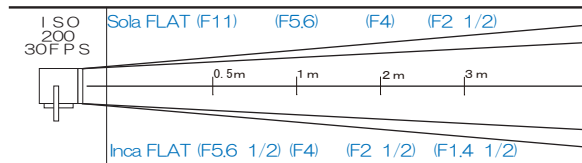

- Dimension 260mm (W) × 420mm (H) × 285mm (D)
- Weight 5kg
- Spigot 17Φ
- Input Power 100V~240V 1.6A
- DMX control system (DMX Cable : optional ¥500)

ACCESSORY

- Including
- Barndoor
- AC Adapter

LED Sola4 (Daylight) / Inca4 (Tungsten)

RENTAL FEE ¥3,000 **2P**

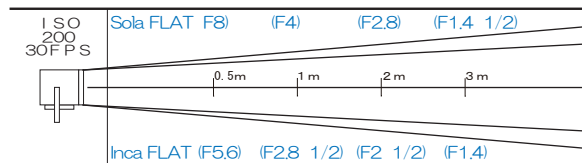

- Dimension 205mm (W) × 335mm (H) × 240mm (D)
- Weight 1.8kg
- Spigot 17Φ
- Input Power 100V~240V 0.55~1.05A
- DMX control system (DMX Cable : optional ¥500)

ACCESSORY

- Including
- Barndoor
- AC Adapter

LED MINI PAR

RENTAL FEE ¥10,000 **2P**

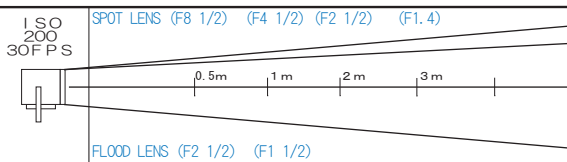

- Light Dimension 53mm (W) × 85mm (D) × 210mm (H)
 - Weight 0.3kg ● Spigot 17Φ ● Input Power 100V 0.09A
- Set items : Daylight fixture 2set Tungsten fixture 2set

ACCESSORY



Vmount Grip
¥ 2,000

LED Zylight Z90

RENTAL FEE ¥8,000 **2P**

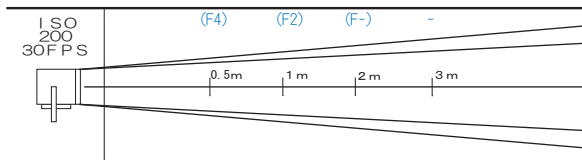

- Dimension 90mm (W) × 190mm (H) × 160mm (D)
- Weight 0.6kg
- Input Power 100/200V (auto sensing) 30W

ACCESSORY



Vmount Grip
¥ 2,000

LED FOCUSING LIGHT

RENTAL FEE ¥5,000

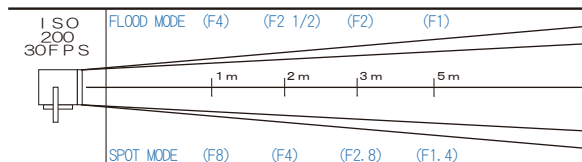

- Light Dimension 135mm (W) × 259mm (H) × 148mm (D)
 - Weight 0.7kg ● Spigot 17Φ (camera shoe mount available)
 - Input Power 34w ● Power consumption 0.34A
- ※ Including Battery

ACCESSORY

● Chimera ¥ 5,000



V Mount Battery continuous lighting time 2hours. (4hours available by spare)

LED RING LIGHT

RENTAL FEE ¥15,000 **2P**

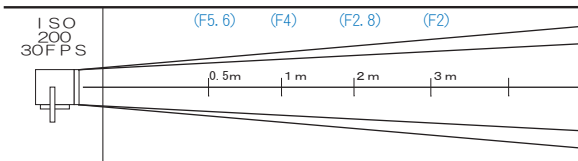

- Light Dimension 510mm (W) × 80mm (D) ● Weight 2.5kg
- Power Supply Dimension 120mm (W) × 160mm (H) × 270mm (D)
- Weight 2kg ● Cord length Long / 15m Short / 8m
- Input Power 100/200V (Automatic switching)



Power Supply



Remote Controller

LED TUBE LIGHT SET

Set of 10 each Tubes ¥8,000 (Frosted / Clear) **2P**

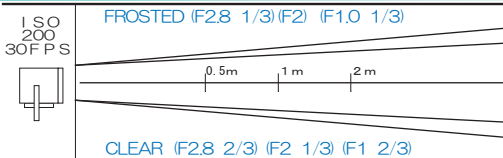
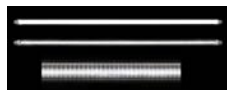

- Dimension 1220mm (W) × 32mm (H) × 40mm (D)
 - Weight 450g ● Input Power 100/200V
- Frosted : Color Temperature about 5300~5700, CC 21M, Flicker Percentage 20%
- Clear : Color Temperature about 5900~6000, CC 18M, Flicker Percentage 20%

※ Rental Fee doesn't include tax.

DICHRONIC LED SET

RENTAL FEE ¥ 5,000

2P



Daylight 5000K Tungsten 3000K
Set of 6 each bulb.
Socket E11
Input Power 4.8w

USHIO DICHRONIC LED SET

RENTAL FEE ¥ 5,000

2P



Daylight 5000K Tungsten 3000K
Set of 5 each bulb.
Socket E11
● Power consumption 0.09A

※Note:
Conversion Cable is optional

ALADDIN POCKET LIGHT

Color ¥ 3,000

D&T set (a set of Daylight × 3 and Tungsten × 3) ¥ 6,000

2P

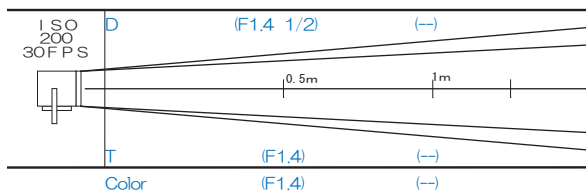

● Dimension 98mm (W) × 38mm (H) × 11mm (D) ● Weight 70g ● Spigot 5Φ
● Input Power 100V~240V (50/60Hz) ● Battery life (1.5 hours)

※Data for Clor is at max output of all colors of RGB. Available colors: R.G.B.C.M.Y.White ● Power consumption 0.08A

ACCESSORY

● Including
● Holder



● AC Adapter



ALADDIN A-Light Bi-color

RENTAL FEE ¥ 6,000

2P

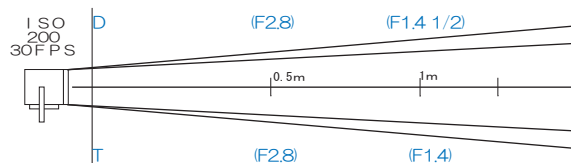

● Dimension 140mm (W) × 70mm (H) × 10mm (D) ● Weight 200g ● Spigot 5Φ
● Input Power 100V~240V (50/60Hz) ● Battery life (70 minutes)
● Charge time of at most 2 hours is needed.

ACCESSORY

● Including
● Charge adapt



● Diffuser



● Screw Dubbo



● nano clamp



LED KELVIN STICK

RENTAL FEE ¥ 10,000

2P



Dimension
40cm (T) × 2
40cm (D) × 2
20cm (T) × 2
20cm (D) × 2
10cm (T) × 2
10cm (D) × 2
5cm (T) × 2
5cm (D) × 2

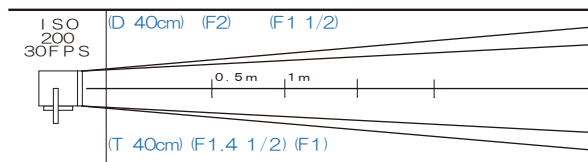

● Input Power 100V
● Accessories : Extension cable, AC Adapter, AA Battery Box

ACCESSORY



V-mount Grip
¥ 2,000



LED

※ Rental Fee doesn't include tax.

LED LIGHTBAR (Daylight/Tungsten/Color) Color ¥15,000 **2P**
Daylight/Tungsten ¥13,000

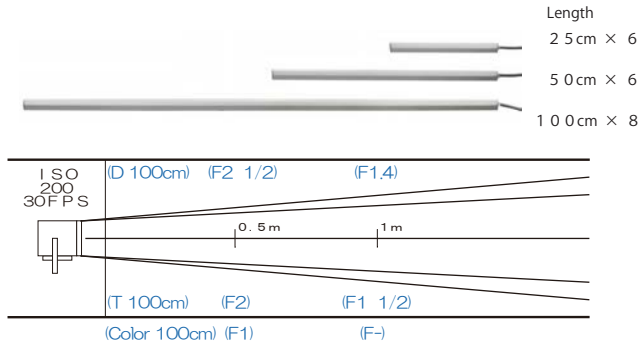

ACCESSORY

- Input Power 100V
- Set items : Dimmer, Cables,

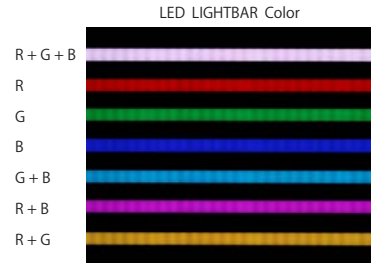

※ Color can be changed by 3dials(R・G・B)

LED SOURCE FOUR (Daylight/Tungsten/Color) Color ¥12,000 **2P**
Bi-Color ¥10,000
Daylight/Tungsten ¥8,000

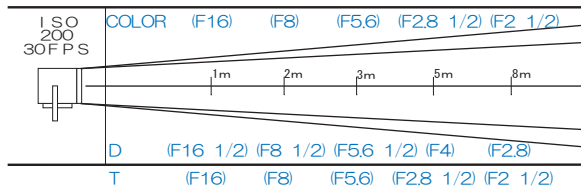

- Dimension 338mm (W) × 460mm (H) × 661mm (D)
- Weight 10.1kg ● Spigot 17Φ
- Input Power 100V (50/60Hz) Daylight 1.66A, Tungsten 1.62A, Color 1.33A

- Including
- 26° Lens
- DMX Controller
- Variable Iris
- Filter Holder
- Gobo Holder

※Please see Page 64 for SOURCE FOUR ACCESSORIES.

LED DEDOLIGHT ZILLA RENTAL FEE ¥5,000 **2P**
(for a set of two)

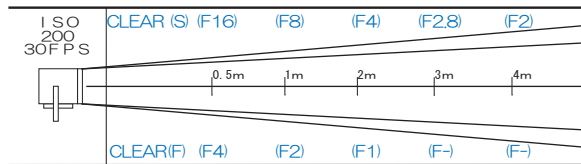

- Dimension 120mm (W) × 240mm (H) × 170mm (D) ● Weight 400g ● Spigot 17Φ
 - Input Power 100V~240V (50/60Hz) / DC 6V~18V 0.08A ● SONY NP-F970 Battery available. (5hours)
- | | | | | |
|------------------------|------------|------------|------|------|
| AMBER (S) (F5.6 1/2) | (F2.8 1/2) | (F1.4 1/2) | (F1) | (F-) |
| AMBER (F) (F2.8 1/2) | (F1.4 1/2) | (F-) | (F-) | (F-) |
| FROSTED (S) (F5.6 1/2) | (F2.8 1/2) | (F1.4 1/2) | (F1) | (F-) |
| FROSTED (F) (F4) | (F2) | (F1) | (F-) | (F-) |

ACCESSORY



ICE LIGHT **2P**
RENTAL FEE ¥3,000

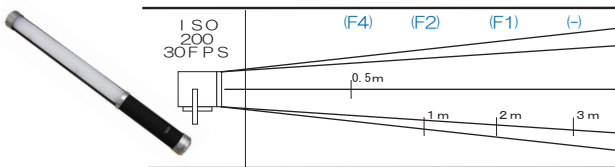

- Dimension 45mm (W) × 510mm (H) ● Weight 600g ● Spigot 17Φ
- Input Power 100/200V (Automatic switching)
- Battery life (3.5hours)

LED LiteParPro **2P**
RENTAL FEE ¥2,000

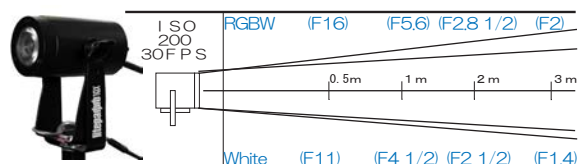

- Dimension 110mm (W) × 220mm (H) × 120mm (D)
- Weight 800g ● Spigot 17Φ
- Input Power 100/200V (Automatic switching) 50/60Hz 0.14A
- DMX512 ● 2 Lights set

FLEX LIGHT 1x4 Bi-color 2P

RENTAL FEE ¥ 18,000

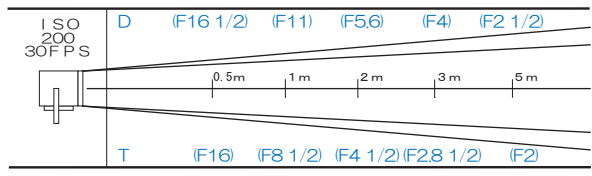

- Dimension 1105mm (W) × 315mm (H) × 90mm (D)
- Weight 3kg
- Spigot 17Φ
- Input Power 100/200V(Automatic switching)
- V-mount Battery available (2hours)
- DMX512

FLEX LIGHT 1x2 Bi-color 2P

RENTAL FEE ¥ 13,000

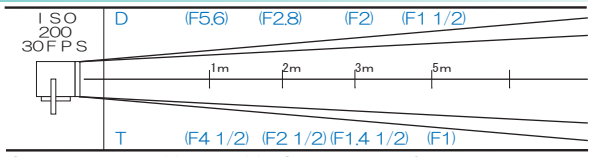

- Dimension 560mm(W)×300mm(H)
- Weight 450g
- Spigot 17Φ
- Input Power 100/200V (Automatic switching) 0.6A
- V-mount Battery available(DAYLIGHT:2.75hours TUNGSTEN:2.5hours)

ACCESSORY

- Including
- Soft Box

FLEX LIGHT D&T 1x1set 2P

RENTAL FEE ¥ 8,000

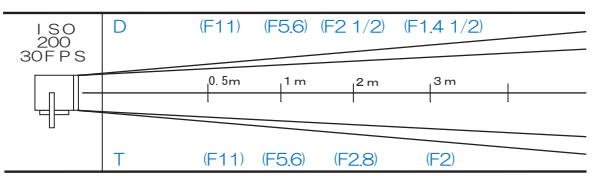

- Dimension 257mm (W) × 257mm (H)
- Weight 210g
- Spigot 17Φ
- Input Power 100/200V(Automatic switching)
- V-mount Battery available (4hours)

FLEX LIGHT Bi-color 2P

RENTAL FEE ¥ 10,500

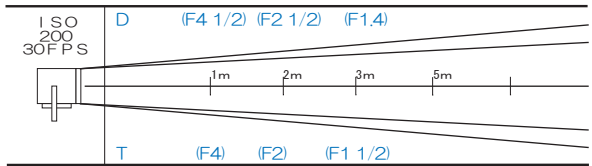
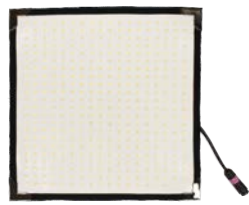

- Dimension 300mm (W) × 300mm (H)
- Weight 400g
- Spigot 17Φ
- Input Power 100/200V (auto sensing)
- V-mount Battery available (DAYLIGHT 2hours 45minutes, TUNGSTEN 2hours 30minutes)

ACCESSORY

- Including
- Soft Box

※ Rental Fee doesn't include tax.

24v CINE KING LIGHT (600w)

RENTAL FEE
¥1,000

※Excluding battery

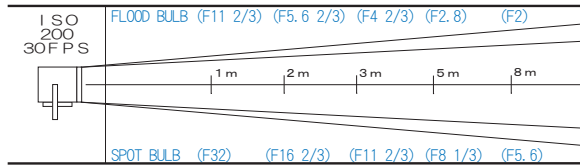

- Light Dimension 270mm (W) × 360mm (H) × 290mm (D)
- Weight 3.5kg ● Lens Diameter 195mm ● Spigot 17φ

24v FOCUSING LIGHT (200w)

RENTAL FEE
¥1,000

※Excluding battery

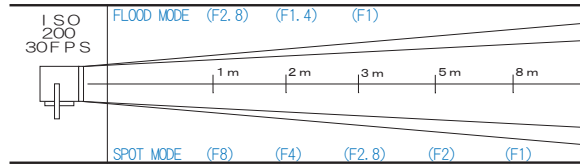

- Light Dimension 132mm (W) × 266mm (H) × 153mm (D)
- Weight 0.7kg
- ※Battery:optional

ACCESSORY

- Chimera ¥5,000

ARRI 575w/1.2kw AC - DC BALLAST

200w/400w DC BALLAST

125w/200w DC BALLAST



¥5,000

- Dimension 200mm (W) × 230mm (H) × 350mm (D)
- Weight 12kg
- Input Power 100/200v DC24v



¥5,000

- Dimension 155mm (W) × 97mm (H) × 274mm (D)
- Weight 3kg ● PowerMax. 490w
- Input Power DC24V



¥5,000

- Dimension 130mm (W) × 65mm (H) × 150mm (D)
- Weight 0.8kg
- Input Power DC24v

24v BATTERY

DRY FIT BATTERY LB-380

DRY FIT BATTERY LB-H4



¥2,500

- Dimension 170mm (W) × 290mm (H) × 410mm (D)
- Weight 17kg
- Output Power 12V 38A /24V 19A



¥2,800

- Dimension 195mm (W) × 210mm (H) × 75mm (D)
- Weight 6.3kg
- Output Power 12/24V 16A



¥2,800

- Dimension 145mm (W) × 241mm (H) × 140mm (D)
- Weight 8.6kg
- Output Power 12/24V 16.8A

SONY Battery Set

NP-F970
2pcs set

V-mount Battery

DUO-150
2pcs set

KINOFLO INVERTER



¥2,000

- SONY Battery × 2
- Charger × 1



- Dimension 38.4mm (W) × 60.0mm (H) × 70.8mm (D)
- Weight 300g
- Output 7.2V 6.3A



¥2,000

- Dimension 91mm (W) × 156mm (H) × 59mm (D)
- Weight 1050g
- Output 14.8 9.8A

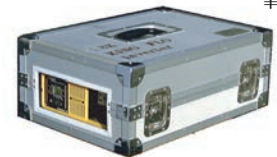

¥8,000

- Dimension 480mm (W) × 185mm (H) × 335mm (D)
- Weight 12kg ● Input Power DC24v
- Output Power 120v 60Hz

※ Rental Fee doesn't include tax.

CHIMERA PLUS BANK / SNOOT / SHUTTER



★DIFFUSER★

GRID CLOTH 1/2
GRID CLOTH 1/4
FULL DIFFUSER

LOUVER



SNOOT



SHUTTER

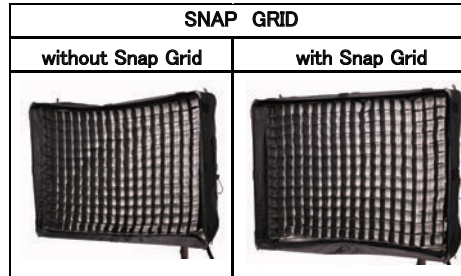

If you use Snap Grid on Chimera, you can keep the tension strong. Please choose the right size Snap Grid suited to each Chimera.

CHIMERA PLUS BANK

LIGHT and RING	CHIMERA PLUS BANK size	LOUVER size	RENTAL FEE	SNAPGRID RENTAL FEE ¥300		
ARRI 24k(T) · ARRI 18k · ARRIMAX18K	SL(DAYLITE PLUS1)	(L)	¥13,000	(SL)		
LTM 18/12k	H1370mm × W1820mm × D1510mm		¥11,000			
ARRI 12k	L(DAYLITE)					
12kARRISUN	H1370mm × W1820mm × D1510mm	(M)	¥7,000	(M)		
6kCP · 12/10k ARRISTUDIO	M(DAYLITE PLUS)					
6k ARRISUN						
4kCP · 5k ARRISTUDIO						
4kARRISUN						
2. 5kARRISUN · 2. 5kARRIMAX						
12/10kP (Adapter + 4kCP Ring)						
2. 5/4kARRIX (Adapter + 4kCP Ring)						
2. 5kCP · 2kARRISTUDIO	S(DAYLITE PLUS)	(S)	¥6,500	(S)		
1. 2kCP · 1kARRISTUDIO · 800wARRIMAX						
1. 2kARRISUN · 1. 8kARRIMAX						
5kP (Adapter + 2.5kCP Ring)						
2kP (Adapter + 1.2kCP Ring)						
1. 2kARRIX (Adapter + 1.2kCP Ring)	PLUS1 S(VIDEO PRO PLUS)	(Chimera S)	¥4,000	X		
PULSAR						
800w Kobold					XS (DAYLITE JUNIOR PLUS)	¥5,000
575wCP · 575wARRISUN						
575wUNI(with adapter)						
400wPARKIT · 200wARRISUN						
200wCP · ARRI 650w						
ARRI 300w · 200wPARKIT · 125wCP						
200w Kobold						
125wPARKIT						
	H300mm × W410mm × D290mm					

SNOOT

	W(mm)	H(mm)	D(mm)	Weight(kg)
6kwCP SNOOT	510	510	410	4.5
4kwCP SNOOT	413	413	275	2.5
2.5kwCP SNOOT ..	343	343	245	2
10/12kwP SNOOT .	430	400	430	4
5kwP SNOOT	310	300	320	2
2kwP SNOOT	270	210	270	1
300w MIZAR	110	110	110	0.15

SHUTTER

	W(mm)	H(mm)	D(mm)	Weight(kg)
18kw HMI.....	850	850	110	11
6/12kw HMI.....	620	620	85	7.5
6kwCP HMI	620	620	62	6.2
4kwCP HMI	490	490	65	4
2.5kwCP HMI	440	440	65	3
1.2kwCP HMI	340	340	65	2
575wCP HMI	280	260	50	1
10/12kwP	490	490	65	3.5
5kwP	380	380	70	3
2kwP	380	380	70	2.5

※ Rental Fee doesn't include tax.

SOURCE FOUR ACCESSORY



DISC TRAY

¥ 4,000 **2P**

※Including 5 Gobo discs.

Disc Tray can use 8-1/2inch Gobo.

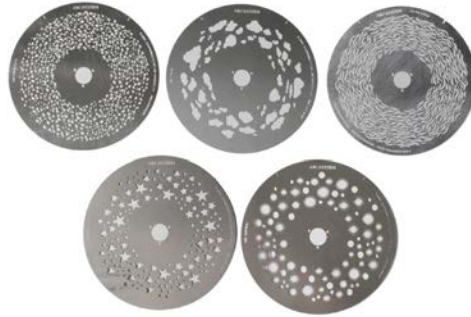

SX4 FOUR GOBO TRAY

¥ 4,500 **2P**

※Excluding Gobo.

Please use with 106 Gobo set.



VOLTEx

¥ 3,000 **2P**

※Including 6 Gobo.



DOUBLE GOBO ROTATOR

¥ 3,000 **2P**

※Including 6 Gobo.



106 GOBO set

¥ 10,000



for both Voltex and
SX4 Four Gobo Tray.



ENDLESS MACHINE

¥ 5,000 **2P**

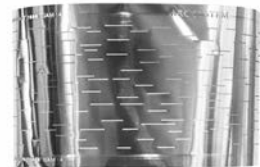

※Including 11 discs.

※ Rental Fee doesn't include tax.

DOORWAY DOLLY



DOORWAY DOLLY

¥ 12,000

● WHEEL KIT (for round rail / for straight rail) ¥ 6,000

● CRIBBING WEDGES SET ¥ 500

※ Tire for straight rail

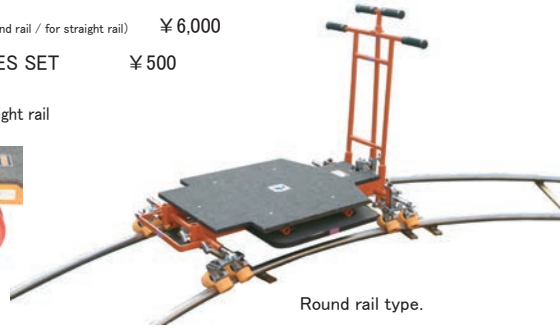

Round rail type.

● STRAIGHT RAIL 2,400mm ¥ 3,000

1,200mm ¥ 3,000

12m ROUND RAIL (Divided into 16 parts) ¥ 3,000 × 16

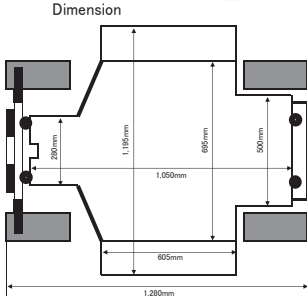

3m ROUND RAIL (Divided into 4 parts)

¥ 3,000 × 4

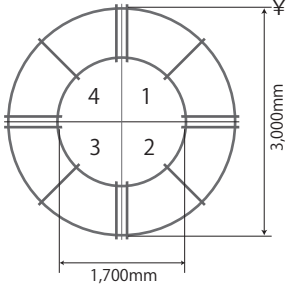

6m ROUND RAIL (Divided into 8 parts)

¥ 3,000 × 8

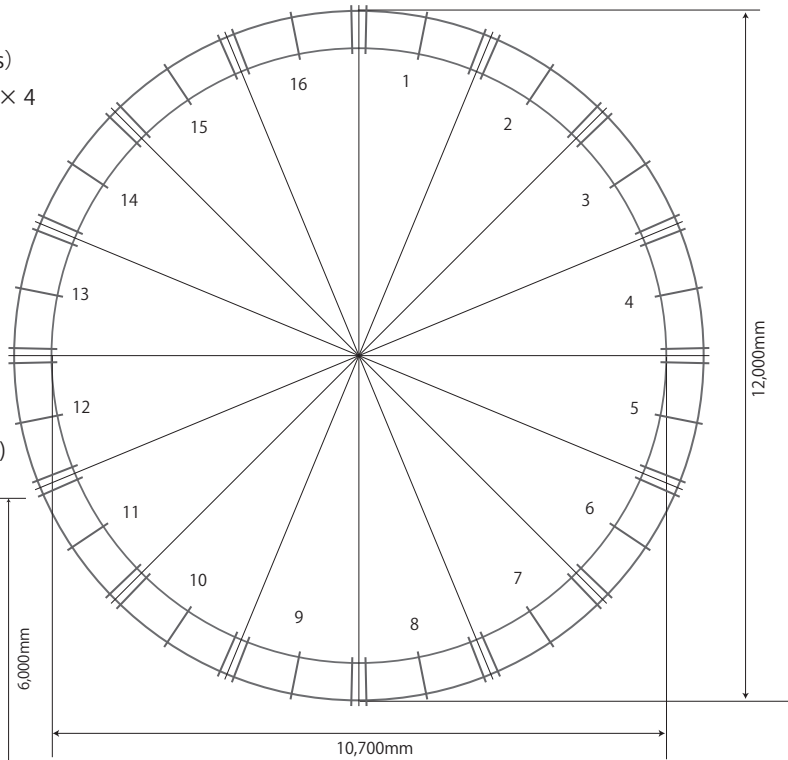
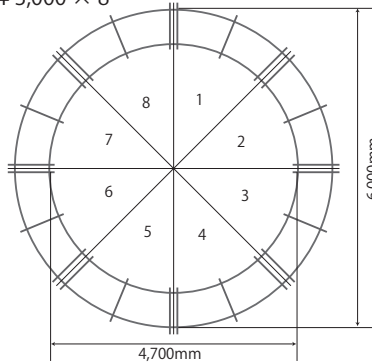

※ Rail Width 625mm (for each rails.)

WESTERN DOLLY

● Wood frame, Tires and Handle are removable.



WESTERN DOLLY

¥ 12,000

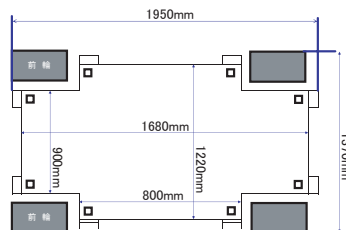

DIMENSION

OTHER EQUIPMENTS

※ Rental Fee doesn't include tax.

TRUSS SYSTEM 253

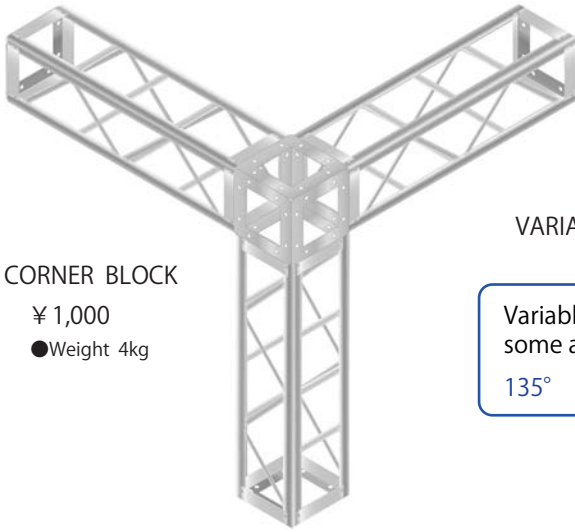

CORNER BLOCK
¥ 1,000
●Weight 4kg

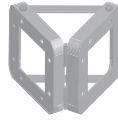

VARIABLE CORNER BLOCK ¥ 1,000
●Weight 6.8g

Variable Corner Blocks can make some angles.

135° 120° 60° 45°

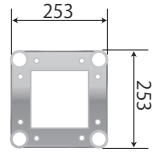

CORNER BLOCK ¥ 1,000



120°
for Triangle
●Weight 4.3kg



60°
for Hexagon
●Weight 3.8kg



45°
for Octagon
●Weight 3.7kg



BASS PLATE
¥ 1,000
●Weight 4kg



DOUBLE BOLTS



0.5m ●Weight 4kg
¥ 1,000



1m ●Weight 7kg
¥ 1,200



2m ●Weight 11.3kg
¥ 2,400



3m ●Weight 15.8kg
¥ 3,600



4m ●Weight 19.6kg
¥ 4,800



5m ●Weight 24.2kg
¥ 6,000

※ Rental Fee doesn't include tax.

TRUSS SYSTEM 253

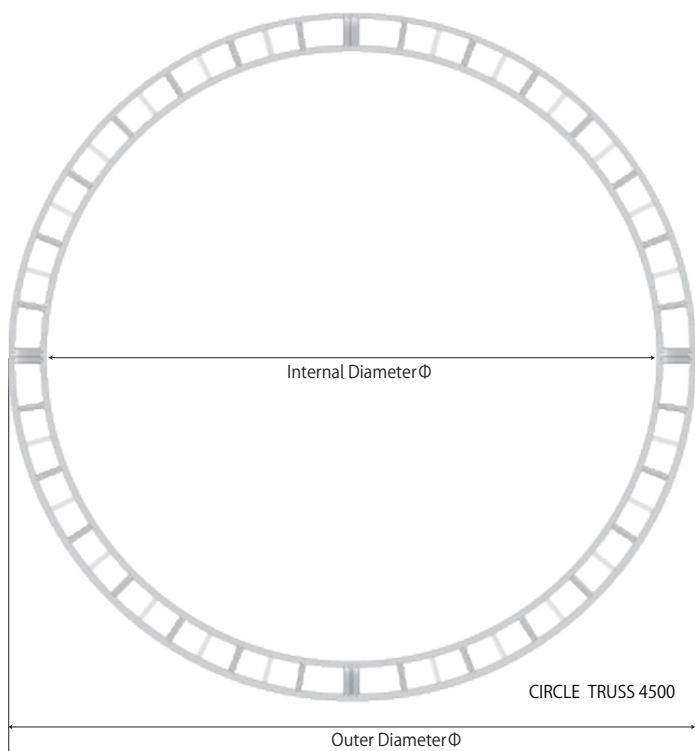

CIRCLE TRUSS 12500

¥84,000 (¥7,000×12)

12500mm (Outer Diameter)
11995mm (Internal Diameter)
Divided into 12 parts.
Weight 220.8kg (18.4kg×12)

CIRCLE TRUSS 9000

¥64,000 (¥8,000×8)

9000mm (Outer Diameter)
8495mm (Internal Diameter)
Divided into 8 parts.
Weight 142.4kg (17.8kg×8)

CIRCLE TRUSS 6500

¥48,000 (¥6,000×8)

6500mm (Outer Diameter)
5995mm (Internal Diameter)
Divided into 8 parts.
Weight 106.4kg (13.3kg×8)

CIRCLE TRUSS 4500

¥28,000 (¥7,000×4)

4500mm (Outer Diameter)
3995mm (Internal Diameter)
Divided into 4 parts.
Weight 70.4kg (17.6kg×4)

CIRCLE TRUSS 3500

¥16,000 (¥4,000×4)

3500mm (Outer Diameter)
2995mm (Internal Diameter)
Divided into 4 parts.
Weight 56.8kg (14.2kg×4)

TRUSS SYSTEM 253 Working load

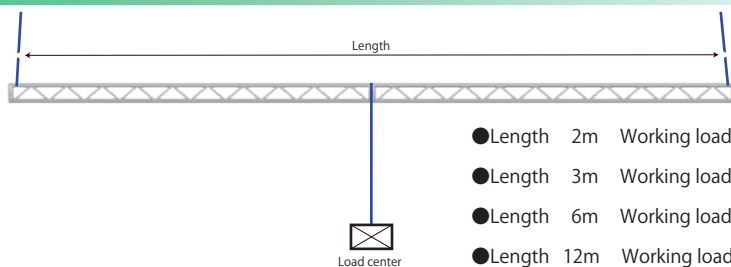

TRUSS RAIL SYSTEM

RENTAL FEE ¥20,000~

253 TRUSS SYSTEM is available
(At least 2m)

TRUSS RAIL SYSTEM BASS	¥20,000	weight 12kg
TRUSS RAIL SYSTEM PIPE		
4 m	¥1,000	weight 9kg
3 m	¥800	weight 7kg
2 m	¥600	weight 5kg

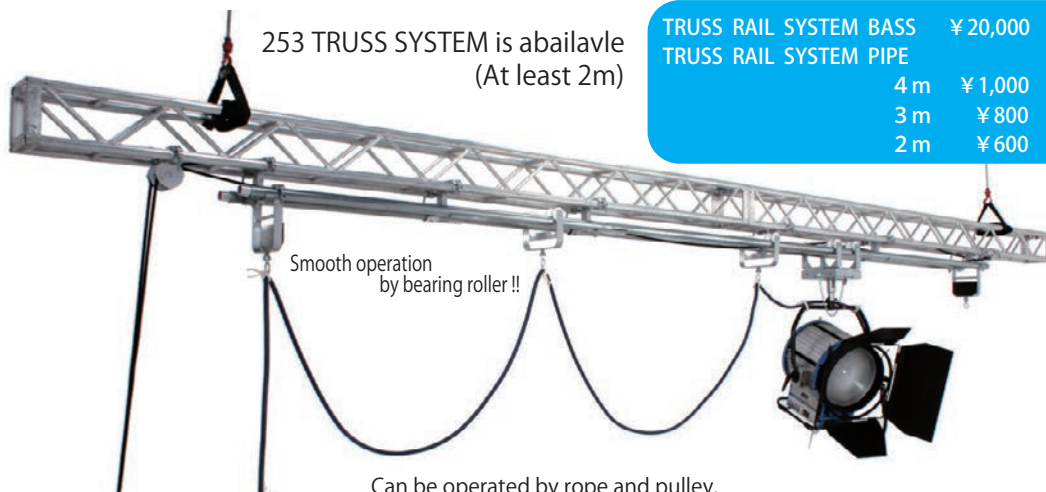

Can be operated by rope and pulley.

Above assembling sample (TRUSS 8 m / moving part 6 m) Total ¥34,800

TRUSS RAIL SYSTEM BASS × 1 ¥20,000 / TRUSS RAIL SYSTEM PIPE 3 m × 4 (¥800 × 4)
253 TRUSS 4 m × 2 (¥4,800 × 2) / ROPE 30 m × 1 ¥2,000

※ Rental Fee doesn't include tax.

STAND CARGO

¥10,000



REAL HOLLYWOOD GRIP



- COMBO STAND × 6
- COMBO TRIPLE STAND × 2
- LOW COMBO STAND × 4
- MAXI STAND × 4
- 5k LAW STAND × 2
- 1k PLATE × 2

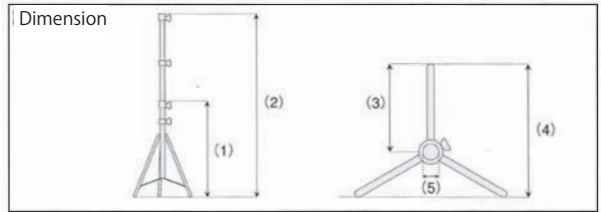

STAND

LONG JOHN SILVER

¥9,600



- (1) 1,770mm (2) 5,700mm
 - (3) 1,350mm (4) 1,900mm
 - (5) 29mm Weight 85kg
- Working load 120kg

SUPER CINEVATOR

¥8,000



- (1) 1,565mm (2) 4,305mm
 - (3) 1,020mm (4) 2,120mm
 - (5) 29mm Weight 72kg
- Working load 91kg

SUPER CINEVATOR S

¥8,000



- (1) 1,570mm (2) 4,300mm
 - (3) 840mm (4) 1,850mm
 - (5) 29mm Weight 69kg
- Working load 91kg

BEACH TIRE

¥10,000



LEVELER

¥1,000



CINEVATOR

¥7,000



- (1) 1,500mm (2) 3,250mm
 - (3) 760mm (4) 1,670mm
 - (5) 29mm Weight 53kg
- Working load 114kg

SUPER CRANK

¥5,000



- (1) 1,460mm (2) 3,350mm
 - (3) 920mm (4) 1,380mm
 - (5) 29mm Weight 55kg
- Working load 90kg

ROAD RUNNER

¥6,000



- (1) 1,285mm (2) 3,370mm
 - (3) 800mm (4) 1,200mm
 - (5) 29mm Weight 55kg
- Working load 99kg

※ Rental Fee doesn't include tax.

mathews
STUDIO EQUIPMENT.

REAL HOLLYWOOD GRIP

STAND

LOWBOY CRANK

¥ 3,000



- (1) 1,000mm (2) 1,660mm
- (3) 620mm (4) 900mm
- (5) 29mm Weight 26kg

Working load 80kg

M CRANK

¥ 3,000



Silver or Black

- (1) 1,615mm (2) 3,885mm
- (3) 830mm (4) 1,460mm
- (5) 29mm Weight 25kg

Working load 34kg

SUPER HIGH STAND

¥ 2,000



- (1) 1,770mm (2) 5,800mm
- (3) 950mm (4) 1,380mm
- (5) 29mm Weight 19kg

Working load 40kg

MOMBO COMBO STAND

¥ 2,000



- (1) 1,770mm (2) 6,800mm
- (3) 950mm (4) 1,380mm
- (5) 29mm Weight 21kg

Working load 40kg

HI-HIGH ROLLER STAND

¥ 2,000



- (1) 2,050mm (2) 6,350mm
- (3) 800mm (4) 1,130mm
- (5) 29mm Weight 20kg

Working load 40kg

HIGH ROLLER STAND

¥ 1,000



- (1) 1,590mm (2) 5,000mm
- (3) 790mm (4) 1,180mm
- (5) 29mm Weight 18kg

Working load 40kg

COMBO TRIPLE STAND

¥ 1,000



Silver or Black

- (1) 1,680mm (2) 4,640mm
- (3) 620mm (4) 980mm
- (5) 25/29mm Weight 14.5kg

Working load 23kg

COMBO STAND

¥ 1,000



- (1) 1,210mm (2) 3,210mm
- (3) 620mm (4) 980mm
- (5) 25/29mm Weight 12kg

Working load 23kg

LOW COMBO STAND

¥ 1,000



Silver or Black

- (1) 910mm (2) 2,020mm
- (3) 360mm (4) 580mm
- (5) 25/29mm Weight 8kg

Working load 33kg

MAXI STAND

¥ 500



- (1) 1,160mm (2) 2,760mm
- (3) 580mm (4) 820mm
- (5) 17mm Weight 6kg

Working load 9kg

BEEFY BABY STAND

¥ 1,000



Silver or Black

- (1) 1,400mm (2) 3,780mm
- (3) 530mm (4) 850mm
- (5) 17mm Weight 6.1kg

Working load 9.1kg

MINI PREMIE BABY STAND

¥ 1,000



- (1) 510mm (2) 960mm
- (3) 230mm (4) 340mm
- (5) 17mm Weight 2.9kg

Working load 10kg

COMBO STAND CASTER

1set ¥ 500



COMBO EXTENSION

¥ 1,000



For 25φ

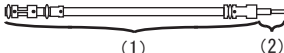

- (1) 1,185mm~1,955mm
- (2) 110mm

STAND COVER

¥ 500



- For COMBO TRIPLE STAND
- For BEEFY BABY STAND
- For LOW COMBO STAND

OTHER EQUIPMENTS

※ Rental Fee doesn't include tax.

STAND

matthews
STUDIO EQUIPMENT.

REAL HOLLYWOOD GRIP

5 k LOW STAND

¥ 500



- (1) 470mm (130mm) (2) 600mm
(3) 260mm (4) 400mm
(5) 25mm Weight 7.2kg
Working load 25kg

1 k LOW STAND

¥ 300



- (1) 280mm (2) 370mm
(3) 170mm (4) 260
(5) 17mm Weight 4kg
Working load 10k

MatthLINK Stand

¥ 500



- (1) 60mm (2) 270mm
(3) 260mm (4) 300mm
(5) 17mm Weight 2kg
Working load 11kg

1 k PLATE

¥ 300



- (1) 60mm (4) 180mm
(5) 17mm Weight 2kg
Working load 10kg

RUNWAY BASE

¥ 800



- (1) 250mm (2) - mm
(3) 730mm (4) 930mm
(5) 29mm Weight 4kg
Working load 113kg

HMI LOW STAND

¥ 500



- (1) 170mm (2) - mm
(3) 570mm (4) 890mm
(5) 29mm Weight 4kg
Working load 100kg

WOOD STAND

¥ 300



- (1) 1,550mm (4) 400mm
Weight 1kg

ALUMINIUM WOOD STAND

¥ 300



- (1) 1,330mm (4) 630mm
Weight 2.4kg

MAGIC STAND

¥ 3,000



- (1) 890mm (2) 1,580mm
(3) 730mm (4) 930mm
(5) 29mm Weight 8kg
Working load 18kg

40' CENTURY STAND

¥ 1,000



Silver or Black

- (1) 1,280mm (2) 2,770mm
(3) 500mm (4) 720mm
(5) 17mm Weight 8kg
Working load 10kg

20' CENTURY STAND

¥ 1,000



Silver or Black

- (1) 760mm (2) 1,080mm
(3) 350mm (4) 530mm
(5) 17mm Weight 5kg
Working load 10kg

DIMENTION

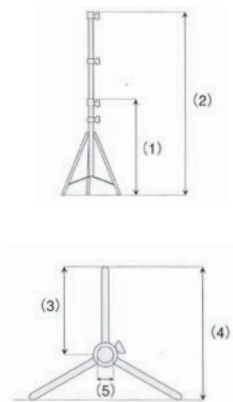

MANFROTTO TRIPOD

¥ 1,700



- (1) 2,480mm (2) 2,730mm
(5) 17mm Weight 7.95kg
Leg Sections 3

Working load 15kg

※Example (Excluding Lighting equipment.)



ALUMINIUM LIGHT BOOM

¥ 2,000

For 17φ

MAX Length/5000mm
MIN Length/1500mm

Weight/1.7kg
Working Load/2.5kg



※Example



※ Rental Fee doesn't include tax.

GRIP



Full size
¥32,000

Half size
¥18,000

CENTURY CARGO

	FULL	HALF		FULL	HALF
MINI END JAW	4	2	GRIP HEAD	10	6
END JAW	10	6	FLAG CLAMP	4	2
CENTER JAW	10	6	M HANGER	2	1
JAR CLAMP	6	4	F CLAMP	10	6
MAFER CLAMP	10	6	ELLEN CLIP	10	6
ALMINUM HANGER	4	2	SPIGOT ADAPTER	4	2
POLY HOLDER	6	4	C-STAND 40'	10	6
BOARD HOLDER	4	2	C-STAND 20'	10	5
BIG BEN CLAMP	4	2	CENTER JAW EX	2	1
			SPACER	2	1

END JAW

¥500



W/180mm H/100mm
D/80mm Weight/0.55kg
Max opening/60mm

CENTER JAW

¥500



W/200mm H/118mm
D/100mm Weight/0.6kg
Max opening/80mm

CENTER JAW EX

¥300



W/23mm Length/268mm
Weight/0.3kg

※ Extender for Center Jaw.

LONG JAW

¥500



W/270mm H/100mm
D/80mm Weight/0.7kg
Max opening/150mm

MINI JAW

¥400



W/144mm H/55mm
D/48mm Weight/0.2kg
Max opening/47mm

JP JAW

¥500



W/192mm H/110mm
D/77mm Weight/0.6kg
Max opening/60mm

MAFER CLAMP

¥300



W/160mm H/140mm
D/45mm Weight/0.5kg
Max opening/60mm

DOOUBLE MAFER

¥400



W/180mm H/140mm
D/45mm Weight/0.9kg
Max opening/60mm

JAR CLAMP

¥300



W/230mm H/140mm
D/30mm Weight/0.45kg
Max opening/80mm

F CLAMP

¥200



W/220mm H/120mm
D/25mm Weight/0.5kg
Max opening/150mm

C CLAMP

¥1,000



W/390mm H/175mm
D/90mm Weight/2.3kg
Max opening/180mm

G CLAMP

¥500

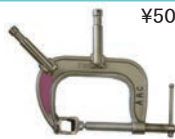

W/270mm H/200mm
D/53mm Weight/1.1kg
Max opening/75mm

CLAMP

¥100



W/200mm H/110mm
D/45mm Weight/0.5kg
Max opening/105mm

FURNITURE CLAMP

各¥500



• L... Max opening 850mm Weight 1.6kg
• M... Max opening 540mm Weight 1.4kg
• S... Max opening 390mm Weight 1.2kg

PELICAN GRIP

¥1,000



W/370mm H/210mm
D/80mm Weight/1.2kg
Max opening/85mm

GRIP HEAD

¥200



W/160mm H/65mm
D/65mm Weight/0.6kg

M HANGER

¥400



※Working load 75kg

W/210mm H/330mm
D/80mm Weight/2.2kg

5 k HANGER

¥300



※Working load 60kg

W/160mm H/200mm
D/70mm Weight/1.4kg
Max opening/50mm

ALUMINUM HANGER

¥300



※Working load 8kg

W/160mm H/140mm
D/45mm Weight/0.5kg
Max opening/60mm

※ Rental Fee doesn't include tax.

GRIP

TUBE TROLLEY

¥3,000



Weight/2.4kg
Working Load/60kg (28Φ)
7.5kg (17Φ Male)

FLAG CLAMP

¥1,000



W/65mm H/250mm~350mm
D/65mm Weight/1.5kg

MINI CENTURY KIT

¥1,000



SUPERFLEX ARM

¥1,000



Weight/1.4kg

3D ARM SET

¥1,500



4 ARM set Weight/0.5kg

Flexible Double Arm Set

¥800



MAGIC GRIP M•F

¥400



MAGIC GRIP F•F

¥400



W/102mm H/205mm
D/105mm Weight/1.4kg

BIG BEN CLAMP

¥400



JUNIOR DROP DOWN

¥1,000



SPIGOT ADAPTER

¥200



- 25φ→17φ / 0.3kg
- 25φ→29φ / 1.4kg
- 29φ→25φ / 1.6kg

HOLLYWOOD HEAD

¥1,000



SUPER GRIP

¥1,000



BOARD HOLDER

¥400



W/150mm H/210mm
D/12mm Weight/0.25kg

POLY HOLDER D

¥600



※ For Double POLY
W/230mm H/270mm
D/63mm Weight/0.5kg

POLY HOLDER D4x8

¥1,000



※ For Double POLY
W/500mm H/340mm
D/63mm Weight/1.3kg

QUAKER CLAMP

¥1,000



W/178mm H/164mm
D/335mm Weight/0.9kg
Max opening/130mm

ELLEN CLIP

¥100



W/80mm H/80mm
D/160mm Weight/0.2kg
Max opening/60mm

PUTTY KNIFE

¥400



W/202mm H/77mm
D/75mm

POLY HOLDER

¥400



W/230mm H/270mm
D/32mm Weight/0.45kg

POLY HOLDER 4x8

¥800



W/500mm H/340mm
D/32mm Weight/1.2kg

SINGLE SPIGOT BRACKET

¥2,000



Max opening 100mm
Weight/5kg ダボ 25Φ

DOUBLE SPIGOT BRACKET

¥3,000



Max opening 100mm
Weight/6.6kg ダボ 25Φ

SUCTION CUP TWIN

¥2,000



W/390mm H/150mm
D/125mm Weight/1.3kg

SUCTION CUP L

¥3,400



W/235mm 高/125mm
D/235mm Weight/1.3kg
Working load 13.5kg

SUCTION CUP S

¥1,400



W/150mm 高/142mm
D/150mm Weight/580g
Working load/9kg

CHAIN VICE

¥800



W/150mm H/320mm
D/80mm Weight/0.55kg
Max opening/140mm

OFFSET ARM

¥1,000



W/470mm~690mm
H/1,500mm
D/30mm Weight/2kg
Working load/7kg

APPLE BOX



Each size
¥400

L..... W/150mm H/450mm D/300mm Weight/4kg
M..... W/75mm H/450mm D/300mm Weight/3kg
S..... W/23mm H/450mm D/300mm Weight/2kg
Pancake.. W/10mm H/450mm D/300mm Weight/1kg

GRIP

GRIP MAT

¥800



W/2,400mm
H/1,750mm
Weight/2kg

RATCHET BELT

¥400



W/50mm
Length/5,900mm
Weight/2kg

RATCHET BELT (S)

¥300



W/34mm
Length/5,000mm
Weight/0.5kg

CHAIN

¥200



※Working load 70kg
Length 1200mm

SAFETY WIRE

¥200



Length 120cm
Working load 50kg

SAFETY WIRE S

¥100



Length 58cm
Working load 20kg
※This wire is for
Little Light Equipment

POLE TRI BRACKET

¥1,200



W/670mm H/670mm
D/50mm Weight/4.5kg

LIGHT PIPE

¥300



W/1,040mm H/43mm
Weight/2kg

OPERATING STICK

¥2,000



6m

FIG RIG

¥1,500



Spigot 17Φ Diameter 475mm
Weight 1kg
※ Excluding Lighting equipment.

BOOM

¥2,000



Working load 10kg*
W/1,900mm~3,320mm
Weight/18.5kg
① spigot 29φ
② spigot 29φ

*Working load is for
when maximum extended.

MJ BOOM

¥2,000



Working load 7kg*
W/1,200mm~2,190mm
Weight/3.9kg
① spigot 17φ
② spigot 17φ

*Working load is for
when maximum extended.

MEGA BOOM

¥10,000



Working load 6kg*
W/2,150mm~3,670mm
Weight/13kg
① spigot 29φ
② spigot 29φ

*Working load is for
when maximum extended.

CHAPS COVER

¥2,000



Available for up to 18k.

AUTO POLE & AUTO POLE JOINT

AUTO POLE
Each size ¥1000

- LL 2,100mm~3,730mm
Weight/2kg
- L 1,480mm~2,700mm
Weight/1.5kg
- M 990mm~1,700mm
Weight/1.3kg
- S 800mm~1,320mm
Weight/0.7kg
- SS 570mm~880mm
Weight/1.5kg

※SS is the Matthews Auto Pole.

AUTO POLE JOINT

Each size ¥500

- 1,990mm Weight/0.7kg
- 1,500mm Weight/0.6kg
- 1,000mm Weight/0.5kg

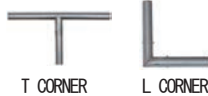

T CORNER L CORNER
※ Can be used both for Auto Pole Joint
and Aluminum Pole Joint.

AUTO POLE STAND

¥1,000



SHOT BAG

¥300



W/170mm Weight/8kg

LIGHT SHOT BAG

¥200



W/95mm Weight/4.5kg

EZ-UP TENT ¥10,000

SIDE WALL ¥1,000

Weight ¥300



W/3,000mm H/3,050mm D/3,000mm

PYLON

¥300



S L

GRASS PROTECTION MAT

¥400

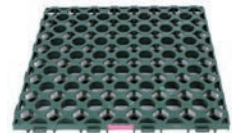

W/485m D/485mm
H/40mm

※ Rental Fee doesn't include tax.

CROSSPOLE

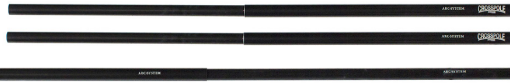

CROSSPOLE A : 3m~5.6m × 1 / 3.25m~6m × 2.....	¥4,000
CROSSPOLE B : 2.2m~4m × 1 / 2m~3.8m × 2.....	¥3,000
CROSSPOLE C : 0.8m~1.3m × 1 / 1.3m~2.2m × 1 / 1.25m~2.3m × 1 ..	¥2,000
CROSSPOLE D : 0.8m~1m × 2.....	¥1,000



CROSSPOLE GRIP SET ¥5,000



※MAX LOAD : 75kg at 6m.

※Crosspole is available for only concrete wall with over 15cm thickness or steel column.

If wall over 5m height, wall need over 30cm thickness.

※Please read instruction manual and get lectured.

※Example
(Excluding Lighting equipment.)



※ Rental Fee doesn't include tax.

GRIP

MAGLINER WIDE

¥2,500



L/1,180mm H/1,300mm
W/675mm Weight/38kg

MAGLINER BEACH

¥10,000



L/1,200mm H/1,060mm
W/950mm Weight/26kg

ALUMINUM 2-WHEEL CART

¥5,000



Dimension when using
L/2,010mm H/865mm W/1,120mm
Dimension when folded
L/1,230mm H/865mm W/540mm
Weight/40kg
Max loading capacity/350kg

MAGLINER ACCESSORY KIT

¥2,500



This Kit can change Magliner to mini carrier.

SHIZU CART

¥500



This Kit can change Shizu cart to mini carrier.

SHIZU CART ACCESSORY KIT

¥500



ALUMILITE MAGLINER

¥2,500

L/1,290mm H/1,190mm
W/550mm Weight/20kg

SUPER CART

¥3,000



This Cart can carry Super Cinevator also.

BACK CARRIER

¥500



GRAB CLAMP PULLEY

¥600



Max opening 170mm
※Working load 150kg

GRAB CLAMP HOOK

¥400



Max opening 170mm

PULLEY



PULLEY(W) ¥600 PULLEY(S) ¥300
※Working load 500kg

ROPE



BORDER ROPE LONG
¥400
12mm×20m
Weight/1.5kg
※Working load 100kg



BORDER ROPE THIN
¥100
8mm×12m
Weight/0.25kg
※Working load 23kg



CLIMBING ROPE 50m
¥2000
1.5mm×50m
Weight/5.9kg
※Working load 800kg



BORDER ROPE THICK
¥200
12mm×12m
Weight/0.75kg
※Working load 100kg



CLIMBING ROPE 30m
¥1500
※Working load 800kg

PANTOGRAPH

¥1,000



•65kg~13kg Stroke 18m
•Weight3.5kg •17Φ

SPRING BALANCER



•60~70kg Stroke1.5m
Weight11.4kg ¥4,000
•50~60kg Stroke1.5m
Weight10.1kg ¥4,000
•22~30kg Stroke1.5m
Weight7.7kg ¥3,000
•15~22kg Stroke1.5m
Weight7.3kg ¥3,000
•9~15kg Stroke1.3
Weight3.8kg ¥3,000

SWIVEL & SHACKLE

¥1,000



※Working load 1.2t

SLING BELT

¥500



※Working load 500kg

30cm SLING & SHACKLE SET

¥1,500



※Working load 2000kg

※ Rental Fee doesn't include tax.

GRIP

WINCH

¥5,000



• 240kg
Lifting height/15m Cable/8m Weight/19kg

AC100v 10.5A 2P

WINCH CONTROLLER

¥15,000



It can control 8 Chain Block.

AC100v 15A 2P

REVERSIBLE HOIST

¥6,000



• 240kg
Lifting height/25m
Cable/10m
Weight/23kg

AC100v 10.5A 2P

REVERSIBLE HOIST CONTROLLER

¥15,000



It can contro 8 Reversible Hoist.

AC100v 15A 2P

ALUMINUM LADDER



9ft Weight/12.7kg ¥900
8ft Weight/6.7kg ¥800
6ft Weight/5.5kg ¥600
4ft Weight/4.1kg ¥500
3ft Weight/3.1kg ¥500

12ft ALUMINUM LADDER



12ft Weight/17kg ¥2,000

TRIPOD ALUMINUM LADDER



9ft Weight/9kg ¥1,500

LADDER

¥2,000



Length/4,650~7,920mm
Weight/22kg

GIANT LADDER

¥2,000



Length/1,900~3,350mm
Weight/24.5kg

LADDER EXTENSION ADAPTER

¥500



※ Can be used only for Aluminum Ladder.

ADJUSTABLE / FIXED CLAMP



ADJUSTABLE CLAMP
FIXED CLAMP
WRENCH each ¥100

HIGH RIDER KIT

¥12,000



• Long 2.5m • Short 2m

HIGH RIDER CORD GUARD

¥3,000



ROLL SLOPE

¥2,500



It can pass over the stair

Length/2,700mm W/330mm Weight/14kg
Working load/300kg



※Folded form

※ Rental Fee doesn't include tax.

GRIP

JLG ACCESS MASTER



¥18,000
 Loading capacity
 Maximum 135kg (Loading Platform expended)
 Minimum 160kg (Loading Platform unexpended)
 JLG Access Master is the battery-powered wheeled lift. Lighting fixture is attachable to this lift.
 W/810mm H/2,060mm ~max 7,000mm
 D/1,420mm Weight/735kg

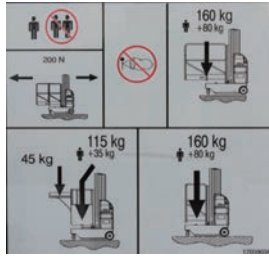

※ To use this lift, certificate for the operation is necessary.
 ※ Lifting is available on flat ground only.

TOWER



6ft TOWER
 1 set ¥4,000
 (Including 3 panels and
 caster 1set)
 W/1,875mm H/1,545mm
 D/1,570mm
 Weight/83.8kg
 (including 3panels)
 ※Excluding outrigger and handrail.

※ Sample image (Tower, Stairs, Opening Panel, Caster)

- 6' Tower side frame ¥1,900
- 6' Brace (Set of 2) ¥200
- Panel ¥1,800
- Panel ¥300 (Which is openable and closable)
- Screw jack (Set of 4) ¥1,000
- Caster (Set of 4) ¥1,000
- Steps ¥4,000
- Outrigger (set of 4) ¥1,500



3ft TOWER • Wood Panel
 1 set ¥1,200 ¥1,800
 W/1,875mm W/1,980mm
 H/890mm H/75mm
 D/1,570mm D/460mm
 Weight/37kg Weight/15kg



※ Sample image (Opening Panel, Stairs)

BEARING CASTER

¥2,000



Weight/12.8kg

JUNIOR GRID CLAMP

¥400



290

T&I CALMP

¥300



LEVEL GUIDE

¥1,000



HSS CLAMP

¥500



HELMET

¥200



LIFE LINE

¥300



WIRE SET

¥2,000



- TIGER EYE
- RING
- WIRE CLIP
- RING CATCH
- SHACKLE
- CARABINER
- TURN BUCKLE
- SPANNER
- CABLE CUTTER

※Excluding wire

ELECTRICAL LEAK PREVENTION SOCKET

¥350



100V 15A

CAR KIT SET

RENTAL FEE ¥3,000



- CAR KIT BASE
- SUN VISOR SPRING HOOK
- INVERTER
- ARM SET
- SUPERFLEX ARM
- CAMERA PLATFORM
- MINI GRIP HEAD
- SPIGOT ADAPTER

OTHER EQUIPMENTS

※ Rental Fee doesn't include tax.

HOUSESTUDIO SET

RENTAL FEE ¥4,000



- For Rail Light.
- Hook × 4
- Female Dowel 17Φ × 4
- 2P Adapter × 4
- Male Dowel 17Φ × 6
- Sealing Adapter × 4
- Socket E25~E17 Adapter × 4
- E25~2P Adapter × 2
- Pulley & Carabiner × 2
- 4 way Clamp × 4
- Downlight Adapter × 4
- Mini Arm Grip × 2

ITEM KIT

RENTAL FEE ¥11,000



- Finger Set
- Dowsing Kit
- Mini Jaw
- 3D Arm
- Mini Grip Head
- Acrylic Cube Set
- Bronze Cube
- Camera Platform Set
- Frexible Arm



Acrylic Cube set



3D ARM

Mini Grip Set

Camera Platform Set

DOWNLIGHT ADAPTER SET

RENTAL FEE ¥500



- Downlight adapter × 6



※Example
(Excluding Lighting equipment.)

MICRO GRIP SET

¥3,000



- Micro Grip Base × 2
- Micro Shot Bag × 2
- Clip w/ 1/4" Thread × 2
- Adapter 3/8" to 1/4" for Micro Grip × 2
- Micro Grip Head × 6
- Hot Shoe Adapter × 2
- Micro Grip Rod (10cm) × 2
- Micro Grip Rod (15cm) × 2
- Micro Grip Rod (20cm) × 2
- Micro Grip Rod (30cm) × 2
- Micro Grip Rod (50cm) × 2
- Carabiner × 2
- Micro Grip Board Holder × 2
- Micro Grip E 17 Cable × 1
- Micro Grip E 25 Cable × 1

MICRO MOUNT SET

¥1,000



- Micro Mount × 2
- Camera Mount × 1
- Hot Shoe Adapter × 1
- Adapter Spigot × 1
- Rod S × 6
- Sphere × 1
- Double Screw × 6

EYELAMP/KRYPTON GRIPSET

¥1,500



- MINI GRIPHEAD × 5
- MINI JAW × 5
- KRYPTON LTYPE SPIGOT × 5
- EYELAMP LTYPE SPIGOT × 5

※ Rental Fee doesn't include tax.

R I G S E T

¥2,000



MagicRiser SET

¥2,000

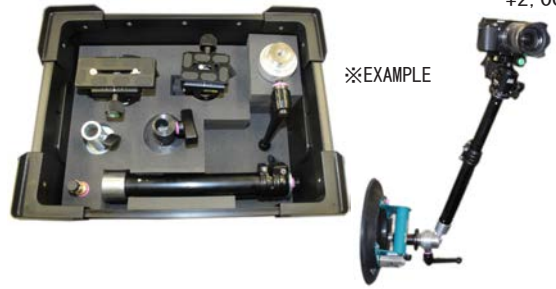

※EXAMPLE

※EXAMPLE

LED MATRIX MULTI COLOR16 GLIP SET

¥1,000

● UPPER LID



2 units connected on the stand



4 units connected hanging with wire

Chimera Aluminium Frame Kit

¥5,000



- No. 5144 / BL × WH 42in × 42in × 1
- No. 5145 / GLD × SIL × Zebra 42in × 42in × 1
- No. 5181 / FULL Diffusion 42in × 82in × 1
- No. 5184 / BL × WH 42in × 82in × 4
- No. 5186 / SIL × BL 42in × 82in × 1
- 42in × 42in FRAME × 1
- 42in × 82in FRAME × 4
- FRAMECLIP × 12

※EXAMPLE



FREE PRIVATE CARGO

RENTAL FEE ¥10,000



Free private cargo including filter sets, expendables, and tools.

Expendables (Charged for quantity used.)

- Tracing paper × 1 (1,250mm × 20m) • Lighting Vinyl × 2 (4,000 × 4m)
- Black Paper × 4 • White Paper × 4 • Wool Paper (High quality) × 1 • Vinyl Bag × 1
- Survival Sheet × 2 • Cutter × 1 • Acrylic Cutter × 1 • Gun Cutter × 1 (for sale)
- Handy Bandler × 1 set • Bungee Cord × 2 set (12) • Bind Wire × 2 (5m)
- Black Cloth × 1 (1,600mm × 4m) • White Cloth × 1 (2,300mm × 4m)
- Black Gauze width S × 8m • Black Gauze width D × 8m • White Gauze width S × 8m
- White Gauze width D × 8m • Pinch × 4 (16入) • Thin Rope × 10 (15m)
- Cotton Work Gloves × 1 dozen • Leather Gloves × 4 • Rubber Gloves × 4
- White Cotton Gloves × 1 • Push Pins × 1 set • Tape set • Aluminun Foil × 1
- Black Wrap width S × 1 • CH Green Tape × 2 • CH Blue Tape × 2 • Silver Knit × 4m
- CH Green Knit × 4m • CH Blue Knit × 4m • Hymilon × 4m • Unbleached Cloth × 4m
- Unon Spray × 1 • K-LINE (White/Black/Gray set) • CRC × 1 • Dulling Spray × 1
- Dulling Clearner × 1

Tools (for rental)

- 3D Arm set × 2 • Mini Jaw × 2 • Mini Grip Head × 2 • Mini Grip Arm × 2
- End Jaw × 2 • Grip Head × 2 • S Clamp × 2 • Flexible Arm × 2 • Board Holder × 2
- Scale for Fluorescent and Kinoflo × 1 set • Hammer × 1 • Saw × 1 • Staple Gun × 1
- Scale × 1 • Pliers × 1 • Monkey Wrench × 1 • Wrench × 1 • Hex Wrench × 1 set
- Screw Driver × 1 set

OTHER EQUIPMENTS

※ Rental Fee doesn't include tax.

POWER SOURCE

5.5kw GENERATOR

Excluding Fuel charge ¥15, 000
Fuel Tank 13.8ℓ



3.7 hours available
at max load.

Noise
60dB

100v/200v Output

W/672mm H/699mm
D/850mm Weight/115kg
Output 100/200 v 50/60Hz
Camlock / 2P×2

2.8kw GENERATOR

Excluding Fuel charge ¥8, 000
Fuel Tank 12.7ℓ



7 hours available
at max load.

Noise
58dB

Parallel generation available

W/450mm H/560mm
D/660mm Weight/70kg
Output 100 v 50/60Hz
C30 / 2P×2

1.6kw GENERATOR

Excluding Fuel charge ¥6, 000
Fuel Tank 3.6ℓ



3.4 hours available
at max load.

Noise
59dB

Parallel generation available

W/510mm H/425mm
D/290mm Weight/22kg
Output 100 v 50/60Hz
2P×2

900w GENERATOR

Excluding Fuel charge ¥4, 000
Fuel Tank 2.1ℓ



3.2 hours available
at max load.

Noise
57dB

Parallel generation available

W/430mm H/370mm
D/230mm Weight/13.5kg
Output 100 v 50/60Hz
2P×2

AC/DC INVERTER

¥30, 000



Cam lock

AC → DC transduce

W/500mm H/440mm
D/790mm
Weight/60kg Capacity/10kw
Transform available
Input/A C 200 v Camlock
Output/D C 100 v Camlock · C60×2

2k FREQUENCY CONVERTER

¥20, 000



C30A

W/420mm H/260mm
D/600mm
Weight/59.1kg Input 100V
Frequency 40Hz~120Hz
Output/C30 · 2P×2

24kw UP TRANSFORMER

¥10, 000



Cam lock

100v→200v/210v/220v/230v

W/800mm H/750mm
D/700mm Weight/206kg
Output/Camlock

10k VARIAC

¥8, 000



Cam lock

AD100A

W/520mm H/665mm
D/485mm Weight/98kg
Output/Camlock · AD100 · C60

2k VARIAC

¥2, 000



C30A 2P

W/320mm H/270mm
D/320mm Weight/15kg
Output/C30 · 2P×4

1k VARIAC

¥2, 000



2P

W/220mm H/200mm
D/240mm Weight/7.8kg
Output/2P×2

3k RHEOSTAT

¥3, 500



C30A

W/65mm H/170mm
D/150mm Weight/1.5kg
Output/D30 · 2P×4

2k RHEOSTAT

¥2, 500



2P

W/65mm H/170mm
D/150mm Weight/1.5kg
Output/2P×2

10k FLICKER MACHINE

¥15, 000



Cam lock

W/515mm H/250mm
D/295mm Weight/14.5kg
Output/Camlock · C60×2
2P×4

6k FLICKER MACHINE

¥10, 000



C60A

(2 k × 3)

W/190mm H/100mm
D/170mm Weight/1.5kg
Output/C30×3

2k FLICKER MACHINE

¥3, 000



C30A 2P

W/190mm H/100mm
D/170mm Weight/1.5kg
Output/2P×4

FREE PLUG IN

¥1, 500



2P

W/460mm H/160mm
D/360mm Weight/8kg

3k DOWN TRANSFORMER

¥2, 000



C30A

W/240mm H/280mm
D/240mm Weight/19kg
Output/2P×4

1k DOWN TRANSFORMER

¥2, 000



2P

W/210mm H/225mm
D/203mm Weight/9.6kg
Output/2P×2

※ Rental Fee doesn't include tax.

POWER SOURCE

300A BREAKER

¥20,000



Camlock

W/500mm H/185mm
D/230mm Weight/11kg

125A BREAKER

¥5,000



Camlock

W/544mm H/157mm
D/263mm Weight/7kg

THREE-PHASE ADAPTER BOX

¥3,000



Camlock

W/320mm H/347mm
D/250mm Weight/5kg



Plug type

SPIDER BOX

POWER BOX A

¥1,400

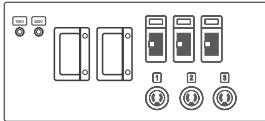

AD type 100A×2
C type 60A×3
2P×3

POWER BOX B

¥1,400

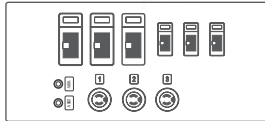

C type 60A×3
C type 30A×3
2P×3

POWER BOX C

¥1,000

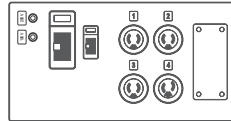

C type 60A×1
C type 30A×1
2P×4

POWER BOX E

¥1,400

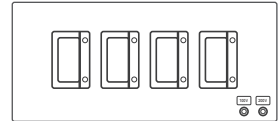

AD type 100A×4

BOX POWER STRIP 60A

¥300



C60A

BOX POWER STRIP 30A

¥300



C30A



POWER CABLE 20m

NAME	CAPACITY	LENGTH	RENTAL FEE
60S Cable	250A	20m	¥600
38S Cable	200A	20m	¥500
22S Cable	150A	20m	¥300
60S Short Cable	250A	2m	¥500

AC DRUM CABLE

¥500



W/200mm H/400mm
D/320mm Weight/6.5kg
Cable Length 30m

C30 2P PARALLEL

¥100



2 P PARALLEL

¥100



NAME	LENGTH	RENTAL FEE	NAME	RENTAL FEE
AD 100A Extension Cable	8m	¥500	ADD100 Adapter	¥500
C60A Extension Cable	8m	¥500	C60D100 Adapter	¥500
C30A Extension Cable	8m	¥300	C30D30 Adapter	¥300
2P Extension Cable	8m	¥200	C60A100 Adapter	¥500
Y plug		¥200	C602WAYAD Adapter	¥500
Female Gender Adapter Cable		¥100	C302WAYC60 Adapter	¥500
Male Gender Adapter Cable		¥100	C60C30 Adapter	¥500
2P6ch Multi Cable	8m	¥1,000	D100A100 Adapter	¥500
C304ch Multi Cable	20m	¥1,000	D30A30 Adapter	¥300
Mini Camlock Earth	20m	¥350	D100C60 Adapter	¥500
C20 2P Parallel		¥100		

CABLE

BARRIER-FREE SLOPE SET

1set ¥3,000



This Slope set moderates uneven ground by cable, and helps pedestrians and vehicles smooth pass over the cable.



GUARD MAT (10 set)
¥1,000
W/500mm H/500mm



YELLOW JACKET
¥2,000
W/970mm H/50mm
D/510mm Weight/10kg



CABLE MAT MINI
for sidewalk only
¥1,000
W/835mm H/40mm
D/430mm Weight/3.6kg



END SLOPE
¥1,000
2set

※ Rental Fee doesn't include tax.

DMX UNIT (FAMA)

3 k 2 4 c h UNIT

DMX available ¥30,000



W/525mm H/505mm D/590mm
Weight/61kg
Input Power 100v
Output Power 100v

6 k 6 c h UNIT

DMX available ¥20,000



幅/520mm H/460mm D/560mm
Weight/39kg
Input Power 100v
Output Power 100v

DMX RECORDER

¥5,000



2P AC 100v

※Programming available.

1 2 k 2 c h UNIT

DMX available ¥15,000



Cam lock

W/680mm H/310mm D/280mm
Weight/20kg
Input Power 100/200v Manual sensing
Output Power 100/200v

1 2 k 1 c h UNIT

DMX available ¥10,000



Cam lock

W/530mm H/310mm D/280mm
Weight/12kg
Input Power 100/200v Manual sensing
Output Power 100/200v

2 P 4 c h UNIT

DMX available ¥3,000 2P

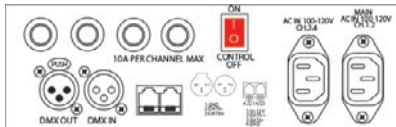
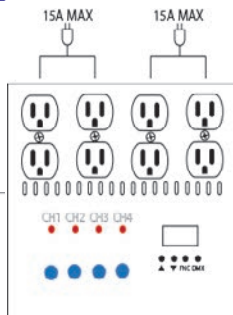

2 P 4 c h UNIT LEPRECON

DMX available ¥3,000 2P

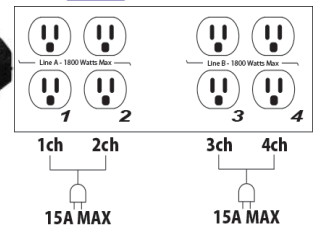

※ Rental Fee doesn't include tax.

DMX UNIT

2 4 k DIMMER

¥15,000



W/680mm
H/310mm
D/280mm
Weight/20kg

Input & Output
Power 200v

Cam lock

※Controlled by dedicated remote controller or analog control by Leprecon. DMX not available.

2 4 c h LEPRECON

¥15,000



DMX Memory Console
2P AC100v

1 2 c h LEPRECON

¥10,000



DMX Memory Console
2P AC100v

FOG MACHINE /HEATER & COOLER /RADIO

DF-50

¥20,000



2P 4.6A

W/360mm H/350mm
D/210mm Weight/18.5kg
Available max 30 hours.

FOG MACHINE VIPER

¥20,000



2P 6.5A

W/350mm H/190mm
D/180mm Weight/5.4kg
Available max 12 minutes.
Continuous working limit is 30 seconds.

FOG MACHINE ROSCO

¥20,000



2P 10.7A

W/500mm H/215mm
D/250mm Weight/13kg

FOG MACHINE TINNY

¥20,000



Operating time max 10 minutes by dedicated battery

W/244mm H/54mm
D/52mm Weight/0.3kg

Remote Control is available.

RE-FAN IV

¥15,000



C30A 21A

W/700mm H/850mm
D/500mm Weight/25kg
Spigot 25Φ

RE-FAN III

¥10,000



2P 16.4A

W/700mm H/850mm
D/500mm Weight/20kg
Spigot 25Φ

RE-FAN II

¥6,000



2P 5.8A

W/470mm H/550mm
D/500mm Weight/15kg
Spigot 25Φ

FAN

¥1,000



2P

HAND BLOWER

¥2,000



2P

100v/6A

SILENT FAN



2P

AC Type
¥4,500



AC DC Type
¥5,400

SILENT FAN ADAPTER

¥500



SPOT COOLER

¥15,000



2P

W/440mm H/840mm
(except nozzle)
D/440mm Weight/48kg
Input Power/800w

VAL 6 PKO

¥8,000



2P

W/633mm H/730mm
D/522mm Weight/30kg
Input Power 110w
Fuel Capacity 30 l (Kerosine)
Operating Time max 15 hours.

HEATER DOUBLE

¥8,000



2P

W/420mm H/1,030mm
D/360mm Weight/12.4kg
Input Power/3kw/200v

※ Rental Fee doesn't include tax.

MOTOROLA RADIO



GDB3500/4800 5set
 ¥16,000
 Recharger 1set ¥500

Digital Radio Frequency

1ch. 351. 20000MHz	16ch. 351. 29375MHz
2ch. 351. 20625MHz	17ch. 351. 30000MHz
3ch. 351. 21250MHz	18ch. 351. 30625MHz
4ch. 351. 21875MHz	19ch. 351. 31250MHz
5ch. 351. 22500MHz	20ch. 351. 31875MHz
6ch. 351. 23125MHz	21ch. 351. 32500MHz
7ch. 351. 23750MHz	22ch. 351. 33125MHz
8ch. 351. 24375MHz	23ch. 351. 33750MHz
9ch. 351. 25000MHz	24ch. 351. 34375MHz
10ch. 351. 25625MHz	25ch. 351. 35000MHz
11ch. 351. 26250MHz	26ch. 351. 35625MHz
12ch. 351. 26875MHz	27ch. 351. 36250MHz
13ch. 351. 27500MHz	28ch. 351. 36875MHz
14ch. 351. 28125MHz	29ch. 351. 37500MHz
15ch. 351. 28750MHz	30ch. 351. 38125MHz

REFLECTOR

B 2 REFLECTOR SET ¥5,000 (2 Reflectors set)

●Dimension 1,400mm (W) × 950mm (H)



SPECIAL LARGE REFLECTOR ¥2,500

●Dimension 1,900mm (W) × 1,400mm (H) ●Weight 9kg

LARGE REFLECTOR ¥1,500

●Dimension 1,400mm (W) × 950mm (H) ●Weight 3kg

MEDIUM REFLECTOR ¥1,000

●Dimension 1,200mm (W) × 800mm (H) ●Weight 2.5kg

SMALL REFLECTOR ¥600

●Dimension 900mm (W) × 600mm (H) ●Weight 2kg



REF ARM ¥500

●Dimension 1,500mm (W) × 535mm (H)

●Weight 4.5kg



Front side

Back side

OVAL REFLECTOR ¥1,000 ●Dimension 1,000mm (W) × 730mm (H) ●Weight 0.5kg



TRI GRIP REFLECTOR ¥1,000

●Dimension 540mm (W) × 540mm (H) ●Weight 0.3kg

By using cover, this Reflector's color can be changed to 7 colors, white, black, silver, gold, stripe gold (2 kinds), stripe silver.



※ Rental Fee doesn't include tax.



Aluminium Hand ReflectorSet ¥1,000

(Silver×1、Gold×1)

●Dimension 615mm (W) ×615mm (H) ●Weight Each 3kg

MIRROR



Large MIRROR ¥3,000 ●Dimension 1,900mm (W) ×990mm (H) ●Weight 34kg

SMALL MIRROR ¥1,500 ●Dimension 960mm (W) ×780mm (H) ●Weight 16.5kg

MIRROR ARM ¥500 ●Dimension 1,300mm (W) ×385mm (H) ●Weight 3.5kg

U S MIRROR ¥3,000 ●Dimension 1,140mm (W) ×1,140mm (H) ●Weight 18kg

U S REFLECTOR ¥3,000 ●Dimension 1,140mm (W) ×1,140mm (H) ●Weight 8kg

U S REFLECTOR LITE

¥3,000 ●Dimension 1,140mm (W) ×1,140mm (H) ●Weight 6kg

U S REFLECTOR LITE(SPOT & FLOOD)

¥3,000 ●Dimension 1,140mm (W) ×1,140mm (H) ●Weight 6kg



REVOLVING MIRROR (Acrylic)

REVOLVING MIRROR L (Acrylic) ¥1,500 ●Dimension 280mm (W) ×300mm (H) ●Weight 2kg

REVOLVING MIRROR S (Acrylic) ¥1,500 ●Dimension 190mm (W) ×200mm (H) ●Weight 1kg

SQUARE REVOLVING MIRROR (Glass) ¥12,000 ●Dimension 340mm (W) ×820mm (H) ●Weight 17.5kg

HEXAGON REVOLVING MIRROR (Glass) ¥12,000 ●Dimension 340mm (W) ×820mm (H) ●Weight 17.5kg



9 P XENON MIRROR ¥18,000 ●MIRROR Size 290mm (W) ×290mm (H) ●Weight 31kg

4 P XENON MIRROR ¥10,000 ●MIRROR Size 290mm (W) ×290mm (H) ●Weight 14kg

6 P REVOLVING XENON MIRROR ¥15,000 ●MIRROR Size 290mm (W) ×290mm (H) ●Weight 15kg



9 P XENON MIRROR



6 P REVOLVING XENON MIRROR



ROUND MIRROR FOR XENON MIRROR ¥1,000



4 P XENON MIRROR



SP REVOLVING MIRROR

¥20,000

MIRROR Size 510mm (W) ×1800mm (H)



AQUA MIRROR III ¥15,000

Can be opened from both side



4 × 4 WS MIRROR

¥5,000



MIRROR BALL

MIRROR BALL 15 cm ¥4,000

2P / Weight 0.9kg

MIRROR BALL 1ft ¥10,000

2P / Weight 3.3kg

MIRROR BALL 1.5ft ¥15,000

C30A / Weight 8kg

※ Rental Fee doesn't include tax.

FRAME

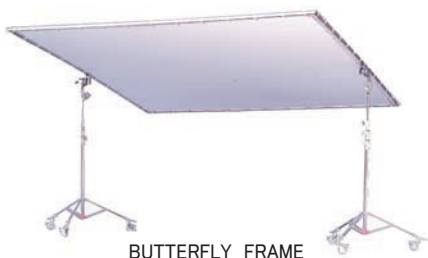

BUTTERFLY FRAME

2 0 F × 2 0 F.....	28kg	¥6,000
2 0 F × 1 0 F.....	21kg	¥6,000
1 2 F × 1 2 F.....	8kg	¥3,000
9 F × 1 2 F.....	7kg	¥2,500
9 F × 9 F.....	6kg	¥2,500
6 F × 9 F.....	5kg	¥1,500
6 F × 6 F.....	4.5kg	¥1,000

BUTTERFLY FRAME (With Velcro)

1 2 F × 1 2 F.....	8kg	¥3,500	9 F × 1 2 F.....	7kg	¥3,000
9 F × 9 F.....	6kg	¥3,000	6 F × 9 F.....	5kg	¥2,000
6 F × 6 F.....	4.5kg	¥2,000			

BUTTERFLY KIT ¥8,000



- 1 ft × 8
- 2 ft × 8
- 3 way corner × 8
- L type × 8
- Joint × 8
- Joint adapter × 4
- 1.5 ft × 8
- 3 ft × 8
- 4 way corner × 4
- T type × 8
- Cross corner × 1

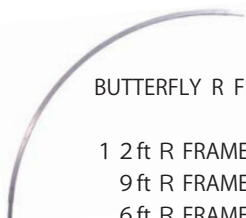

BUTTERFLY R FRAME

1 2 ft R FRAME	¥1,000
9 ft R FRAME	¥800
6 ft R FRAME	¥600
3 ft R FRAME	¥500



U FRAME ¥3,000

- L (825mm × 1,455mm)
- M (625mm × 1,055mm)
- S (475mm × 755mm)



BUTTERFLY
1 2 × 1 2
¥4,000



BUTTERFLY W GRIP
¥1,000



BUTTERFLY GRIP
¥1,000
• for 2 0 × 2 0
• for 1 2 × 1 2



BUTTERFLY
CART
¥500



SPEED CLIP
¥200



BUTTERFLY CORNER GUARD
¥2,000

For protection wall or floor!

AUTOPOLE JOINT



AUTOPOLE JOINT 2 m	¥500
AUTOPOLE JOINT 1 m	¥500
Corner L	¥500
T Joint	¥500

PIPE & CORNER



1m Pipe	¥200	2m Pipe	¥400
2.7m Pipe	¥400	3m Pipe	¥400
4m Pipe	¥400		
Corner L	¥300	Joint	¥200
T Joint	¥200 (Plastic)		

ALMINUM PIPE

4 m Alminum Pipe	¥1,000
3 m Alminum Pipe	¥800
2 m Alminum Pipe	¥600
1 m Alminum Pipe	¥400
Corner L	¥1,000
Joint	¥600

ALMINUM POLE JOINT



300mm	¥400	Weight 0.3kg	1,900mm	¥600	Weight 1.2kg
500mm	¥400	Weight 0.4kg	2,000mm	¥600	Weight 1.3kg
1,000mm	¥400	Weight 0.7kg	3,000mm	¥800	Weight 2kg
1,500mm	¥600	Weight 1kg	4,000mm	¥1000	Weight 2.5kg

PIPE

5 m Pipe	¥1,000	4 m Pipe	¥800
3 m Pipe	¥600	2 m Pipe	¥400
1 m Pipe	¥200	Joint	¥200
Movable Clamp	¥100	Fixed Clamp	¥100
Wrench	¥100		

JRP CORNER

For making Frame with red deal. ¥5,000



4way Corner x 4 3way Corner x 8 4 way Cross x 2 Corner L x 4 Straight x 4

※ Rental Fee doesn't include tax.

FRAME

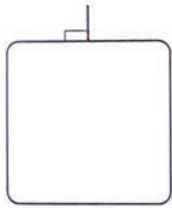

FRAME



4 × 4 CUCOLORIS



FLAG

CIRCLE FRAME SET ¥3,000

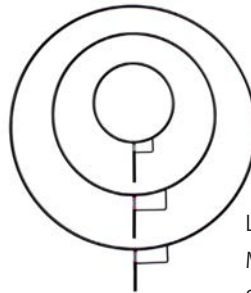

- L 900mm
- M 600mm
- S 300mm

- 5 F × 5 F FRAME (1,680mmx1,530mm 2kg)..... ¥ 800
- 4 F × 4 F FRAME (1,360mmx1,220mm 1.5kg)..... ¥ 600
- 3 F × 3 F FRAME (1,000mmx1,170mm 1.5kg)..... ¥ 400
- 2 F × 2 F FRAME (800mmx960mm 1.2kg)..... ¥ 400
- 1 F × 1 F FRAME (600mmx750mm 0.9kg)..... ¥ 400
- 4 F × 4 F CUCOLORIS (1,215mmx1,220mm 2.5kg)..... ¥ 2,000
- 4 F × 4 F FLOPPY (1,220mmx1,225mm 2.8kg)..... ¥ 1,500
- FLAG (600mm × 960mm 1kg)..... ¥ 500
- FLAG (450mm × 750mm 0.9kg)..... ¥ 400
- FLAG (300mm × 600mm 0.7kg)..... ¥ 200



STAINLESS FLAG set
¥6,000
(LC2 M×2 S×2)



HOT FLAG SET
¥2,000
L size (2 sheets set)
1,200mm×1,400mm

※Flame retardant black FLAG

STAINLESS FLAG

- L 1,200mm×1,400mm
- M 600mm×900mm
- S 450mm×600mm



BLACK SOLID SET
¥6,000
ALL size × 2

BLACK SOLID

- 1220mm×610mm
- 1220mm×470mm
- 1830mm×610mm
- 1070mm×260mm



DOT & FINGER
¥3,000
Weight1.5kg



SURVIVAL KIT ¥5,000



BT FLAG COVER
¥2,000



FLEX FRAME OPEN END
¥1,000

L · M · S set
Weight0.7kg

BT
L × 3 M × 3 S × 3
Weight 10.4kg

※ Rental Fee doesn't include tax.

FRAME



Wire Scrim Set
L · M · S
Single / Double
Set of 2 sheets.
¥7,500



Celo Cucoloris Set ¥6,000
L · M · S each size x 2 sheets set
4 x 4 size x 2 sheets set ¥3,000



4x4 Egg Crate Grid ¥1,500

FRAME HOLDER

1set ¥1,000



WATER TANK



•6F x 6F ¥19,000
H / 220mm Weight / 64kg

•4F x 4F ¥14,000
H / 150mm W / 25kg

FRAME Weight / 21kg
¥1,000

FRAME Weight / 15kg
¥1,000



Vertical Water Tank
¥6,000
Tank Size 600mm (H) x 640mm (W) x 160mm (D)
Spigot 25Φ



Hose Reel ¥500
Hose Length 20m

ACRYLIC DOME



Lacteous Acrylic Dome	900Φ	¥8,000
Lacteous Acrylic Dome	600Φ	¥4,000
Lacteous Acrylic Dome	400Φ	¥2,000
Clear Acrylic Dome	600Φ	¥4,000
Clear Acrylic Dome	400Φ	¥2,000



SUN SWATTER - L ¥5,000
SUN SWATTER - S ¥3,000

BRANCHES & LEAVES



SMILAX ¥9,000



BRANCHES ¥5,000



TWIG SET
Set of 5 pieces.
¥2,000

※ Rental Fee doesn't include tax.

SET PAPER SYSTEM KIT



¥1,000



※Example
(Excluding High stand, Set paper and Shot bag.)

CHROMA FLEX

2P



Changing the art of
chroma key

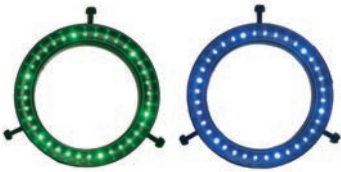

Color choice for LED Ring Light : Blue , Green.
Available camera lens: 60.3 ~ 115.8mm.
This ring is removable easily.

Chroma Flex is the system which make Chroma key background by using blue or green LED Ring Light for standard lens and particular reflecting gray cloth for back ground. This cloth looks normal gray color for human eyes. But for camera, this cloth looks uniform brightness and chroma, and it becomes high quality background source to edit or composite .

Chroma Flex doesn't need traditional lighting for using chroma key set.

6 m × 8 m	¥ 4 8 , 0 0 0
3 m × 4 m	¥ 2 4 , 0 0 0
6 F × 6 F	¥ 1 2 , 0 0 0

※ Rental charge is per day. Rental charge is for the set of LED Ring Light and background cloth.



CLOTH

Black Solid			
Size	RENTAL FEE		
8 m × 1 0 m	¥	15,000	
8 m × 1 0 m B T	¥	35,000	
5 m × 8 m	¥	7,000	
4 m × 6 m	¥	5,000	
3 m × 5 m	¥	4,000	
9 F × 7 m B T	¥	12,000	
6 F × 7 m B T	¥	10,000	
3 F × 7 m B T	¥	7,000	
3.6 m × 5.4 m B T	¥	13,000	
2 0 F × 2 0 F B T	¥	15,000	
1 2 F × 1 2 F B T	¥	10,000	
9 F × 1 2 F B T	¥	8,000	
9 F × 9 F B T	¥	7,000	
6 F × 9 F B T	¥	5,000	
6 F × 6 F B T	¥	4,000	
0.9 m × 3 m for sky	¥	1,600	
0.9 m × 4.7 m for sky	¥	2,000	

Black Solid (Fireproof)			
Size	RENTAL FEE		
8 m × 1 0 m	¥	19,000	
5 m × 8 m	¥	9,000	
4 m × 6 m	¥	6,500	
3 m × 5 m	¥	5,200	
9 F × 7 m	¥	6,500	
6 F × 7 m	¥	5,000	
3 F × 7 m	¥	4,000	

Black Silk			
Size	RENTAL FEE		
2 0 F × 2 0 F	¥	10,000	
1 0 F × 2 0 F	¥	7,000	
1 2 F × 1 2 F	¥	4,000	
9 F × 1 2 F	¥	3,500	
9 F × 9 F	¥	3,000	
6 F × 9 F	¥	3,000	
6 F × 6 F	¥	2,000	

Black Solid B T MG (With Velcro)			
Size	RENTAL FEE		
1 2 F × 1 2 F	¥	10,000	
9 F × 1 2 F	¥	8,000	
9 F × 9 F	¥	7,000	
6 F × 9 F	¥	5,000	
6 F × 6 F	¥	4,000	

Black Silk (Fireproof)			
Size	RENTAL FEE		
2 0 F × 2 0 F	¥	13,000	
1 0 F × 2 0 F	¥	9,000	
1 2 F × 1 2 F	¥	5,000	
9 F × 1 2 F	¥	4,500	

Black & White Silk			
Size	RENTAL FEE		
2 0 F × 2 0 F	¥	15,000	
1 2 F × 1 2 F	¥	8,000	
9 F × 1 2 F	¥	6,000	
9 F × 9 F	¥	5,000	
6 F × 9 F	¥	4,000	
6 F × 6 F	¥	3,000	
9 F × 7 m	¥	8,000	
6 F × 7 m	¥	6,000	
3 F × 7 m	¥	5,000	

Black Silk MG (With Velcro) (Fireproof)			
Size	RENTAL FEE		
1 2 F × 1 2 F	¥	3,000	
9 F × 1 2 F	¥	3,000	
9 F × 9 F	¥	3,000	
6 F × 9 F	¥	2,000	
6 F × 6 F	¥	2,000	

Black & White Silk (Fireproof)			
Size	RENTAL FEE		
1 2 F × 1 2 F	¥	10,000	
9 F × 1 2 F	¥	8,000	

White Silk			
Size	RENTAL FEE		
1 5 m × 2 0 m	¥	30,000	
1 3 m × 1 5 m	¥	25,000	
9 m × 1 2 m	¥	20,000	
1 0 m × 1 0 m	¥	20,000	
2 0 F × 2 0 F	¥	10,000	
1 0 F × 2 0 F	¥	7,000	
1 2 F × 1 2 F	¥	4,000	
9 F × 1 2 F	¥	3,500	
9 F × 9 F	¥	3,000	
6 F × 9 F	¥	3,000	
6 F × 6 F	¥	2,000	

White Silk (Fireproof)			
Size	RENTAL FEE		
1 5 m × 2 0 m	¥	39,000	
1 3 m × 1 5 m	¥	32,000	
9 m × 1 2 m	¥	26,000	
1 0 m × 1 0 m	¥	26,000	
2 0 F × 2 0 F	¥	13,000	
1 0 F × 2 0 F	¥	10,000	
1 2 F × 1 2 F	¥	5,000	
9 F × 1 2 F	¥	4,500	

White Silk MG (With Velcro) (Fireproof)			
Size	RENTAL FEE		
1 2 F × 1 2 F	¥	4,000	
9 F × 1 2 F	¥	3,500	
9 F × 9 F	¥	3,000	
6 F × 9 F	¥	3,000	
6 F × 6 F	¥	2,000	

CLOTH

Taffuta Silk			
Size			RENTAL FEE
1 5 m	×	2 0 m	¥ 30,000
1 3 m	×	1 5 m	¥ 25,000
9 m	×	1 2 m	¥ 20,000
1 0 m	×	1 0 m	¥ 20,000
2 0 F	×	2 0 F	¥ 10,000
1 0 F	×	2 0 F	¥ 10,000
1 2 F	×	1 2 F	¥ 5,000
9 F	×	1 2 F	¥ 4,000
9 F	×	9 F	¥ 4,000
6 F	×	9 F	¥ 3,000
6 F	×	6 F	¥ 2,000
9 F	×	7 m	¥ 5,000

Chimera Silk			
Size			RENTAL FEE
2 0 F	×	2 0 F	¥ 10,000
1 0 F	×	2 0 F	¥ 10,000
1 2 F	×	1 2 F	¥ 6,000
9 F	×	1 2 F	¥ 5,000
9 F	×	9 F	¥ 4,000
6 F	×	9 F	¥ 3,000
6 F	×	6 F	¥ 2,000

Unbleached Muslin			
Size			RENTAL FEE
1 5 m	×	2 0 m	¥ 30,000
9 m	×	1 2 m	¥ 20,000
6 m	×	8 m	¥ 15,000
2 0 F	×	2 0 F	¥ 10,000
1 0 F	×	2 0 F	¥ 10,000
1 2 F	×	1 2 F	¥ 5,000
9 F	×	1 2 F	¥ 4,000
9 F	×	9 F	¥ 4,000
6 F	×	9 F	¥ 3,000
6 F	×	6 F	¥ 2,000

Grid Cloth			
Size			RENTAL FEE
2 0 F	×	2 0 F	¥ 10,000
1 2 F	×	1 2 F	¥ 6,000
9 F	×	1 2 F	¥ 5,000
9 F	×	9 F	¥ 4,000
6 F	×	9 F	¥ 3,000
6 F	×	6 F	¥ 2,000

Silent Grid Cloth			
Size			RENTAL FEE
1 3 m	×	1 5 m	¥ 25,000
1 2 m	×	9 m	¥ 20,000
1 2 m	×	7 m	¥ 20,000
2 0 F	×	2 0 F	¥ 10,000
1 0 F	×	2 0 F	¥ 10,000
1 2 F	×	1 2 F	¥ 6,000
9 F	×	1 2 F	¥ 5,000
9 F	×	9 F	¥ 4,000
6 F	×	9 F	¥ 3,000
6 F	×	6 F	¥ 2,000

Satin			
Size			RENTAL FEE
1 5 m	×	2 0 m	¥ 30,000
1 3 m	×	1 5 m	¥ 25,000
9 m	×	1 2 m	¥ 20,000
2 0 F	×	2 0 F	¥ 10,000
1 0 F	×	2 0 F	¥ 10,000
1 2 F	×	1 2 F	¥ 5,000
9 F	×	1 2 F	¥ 4,000
9 F	×	9 F	¥ 4,000
6 F	×	9 F	¥ 3,000
6 F	×	6 F	¥ 2,000

Ultra Bounce			
Size			RENTAL FEE
2 0 F	×	2 0 F	¥ 15,000
1 0 F	×	2 0 F	¥ 15,000
1 2 F	×	1 2 F	¥ 8,000
9 F	×	1 2 F	¥ 6,000
9 F	×	9 F	¥ 5,000
6 F	×	9 F	¥ 4,000
6 F	×	6 F	¥ 3,000

China Silk			
Size			RENTAL FEE
2 0 F	×	2 0 F	¥ 15,000
1 2 F	×	1 2 F	¥ 10,000
9 F	×	1 2 F	¥ 8,000
9 F	×	9 F	¥ 7,000
6 F	×	9 F	¥ 5,000
6 F	×	6 F	¥ 4,000

1/4 Stop Silk			
Size			RENTAL FEE
2 0 F	×	2 0 F	¥ 15,000
1 2 F	×	1 2 F	¥ 10,000
9 F	×	1 2 F	¥ 8,000
9 F	×	9 F	¥ 7,000
6 F	×	9 F	¥ 5,000
6 F	×	6 F	¥ 4,000

Grid Cloth Lite			
Size			RENTAL FEE
2 0 F	×	2 0 F	¥ 10,000
1 2 F	×	1 2 F	¥ 6,000
9 F	×	1 2 F	¥ 5,000
9 F	×	9 F	¥ 4,000
6 F	×	9 F	¥ 3,000
6 F	×	6 F	¥ 2,000

Silent Grid Cloth Lite			
Size			RENTAL FEE
1 3 m	×	1 5 m	¥ 25,000
1 2 m	×	9 m	¥ 20,000
2 0 F	×	2 0 F	¥ 10,000
1 0 F	×	2 0 F	¥ 10,000
1 2 F	×	1 2 F	¥ 6,000
9 F	×	1 2 F	¥ 5,000
9 F	×	9 F	¥ 4,000
6 F	×	9 F	¥ 3,000
6 F	×	6 F	¥ 2,000

※ Rental Fee doesn't include tax.

CLOTH

A 1 Grid Cloth			
Size			RENTAL FEE
2 0 F	×	2 0 F	¥ 15,000
1 2 F	×	1 2 F	¥ 10,000
9 F	×	1 2 F	¥ 8,000
9 F	×	9 F	¥ 7,000
6 F	×	9 F	¥ 5,000
6 F	×	6 F	¥ 4,000

A 3 Grid Cloth			
Size			RENTAL FEE
2 0 F	×	2 0 F	¥ 15,000
1 2 F	×	1 2 F	¥ 10,000
9 F	×	1 2 F	¥ 8,000
9 F	×	9 F	¥ 7,000
6 F	×	9 F	¥ 5,000
6 F	×	6 F	¥ 4,000

B 1 Grid Cloth			
Size			RENTAL FEE
2 0 F	×	2 0 F	¥ 15,000
1 2 F	×	1 2 F	¥ 10,000
9 F	×	1 2 F	¥ 8,000
9 F	×	9 F	¥ 7,000
6 F	×	9 F	¥ 5,000
6 F	×	6 F	¥ 4,000

B 3 Grid Cloth			
Size			RENTAL FEE
2 0 F	×	2 0 F	¥ 15,000
1 2 F	×	1 2 F	¥ 10,000
9 F	×	1 2 F	¥ 8,000
9 F	×	9 F	¥ 7,000
6 F	×	9 F	¥ 5,000
6 F	×	6 F	¥ 4,000

B 1 Grid Cloth Lite			
Size			RENTAL FEE
2 0 F	×	2 0 F	¥ 15,000
1 2 F	×	1 2 F	¥ 10,000
9 F	×	1 2 F	¥ 8,000
9 F	×	9 F	¥ 7,000
6 F	×	9 F	¥ 5,000
6 F	×	6 F	¥ 4,000

B 3 Grid Cloth Lite			
Size			RENTAL FEE
2 0 F	×	2 0 F	¥ 15,000
1 2 F	×	1 2 F	¥ 10,000
9 F	×	1 2 F	¥ 8,000
9 F	×	9 F	¥ 7,000
6 F	×	9 F	¥ 5,000
6 F	×	6 F	¥ 4,000

Hight Light			
Size			RENTAL FEE
2 0 F	×	2 0 F	¥ 15,000
1 2 F	×	1 2 F	¥ 8,000
9 F	×	1 2 F	¥ 6,000
9 F	×	9 F	¥ 5,000
6 F	×	9 F	¥ 4,000
6 F	×	6 F	¥ 3,000

Doma Vinyl			
Size			RENTAL FEE
2 0 F	×	2 0 F	¥ 6,000
1 2 F	×	1 2 F	¥ 4,000
9 F	×	1 2 F	¥ 3,000
9 F	×	9 F	¥ 3,000
6 F	×	9 F	¥ 2,000
6 F	×	6 F	¥ 2,000

Wind Protection Net / White			
Size			RENTAL FEE
2 0 F	×	2 0 F	¥ 12,000
1 2 F	×	1 2 F	¥ 8,000
9 F	×	1 2 F	¥ 7,000
9 F	×	9 F	¥ 6,000
6 F	×	9 F	¥ 4,000
6 F	×	6 F	¥ 3,000

Wind Protection Net / Black			
Size			RENTAL FEE
2 0 F	×	2 0 F	¥ 12,000
1 2 F	×	1 2 F	¥ 8,000
9 F	×	1 2 F	¥ 7,000
9 F	×	9 F	¥ 6,000
6 F	×	9 F	¥ 4,000
6 F	×	6 F	¥ 3,000

Wind Protection Net / Silver			
Size			RENTAL FEE
2 0 F	×	2 0 F	¥ 12,000
1 2 F	×	1 2 F	¥ 8,000
9 F	×	1 2 F	¥ 7,000
9 F	×	9 F	¥ 6,000
6 F	×	9 F	¥ 4,000
6 F	×	6 F	¥ 3,000

Black Net / White Net (Single& Double) <small>(Fireproof)</small>			
Size			RENTAL FEE
2 0 F	×	2 0 F	¥ 15,000
2 0 F	×	1 0 F	¥ 15,000
1 2 F	×	1 2 F	¥ 10,000
9 F	×	1 2 F	¥ 8,000
9 F	×	9 F	¥ 7,000
6 F	×	9 F	¥ 5,000
6 F	×	6 F	¥ 4,000

CLOTH

Egg Crate

Size	RENTAL FEE
2 0 F × 2 0 F	¥ 40,000
1 2 F × 1 2 F	¥ 18,000
9 F × 1 2 F	¥ 15,000
9 F × 9 F	¥ 14,000
6 F × 9 F	¥ 12,000
6 F × 6 F	¥ 10,000

Checkerboard Lame

Size	RENTAL FEE
2 0 F × 2 0 F	¥ 15,000
1 2 F × 1 2 F	¥ 10,000
9 F × 1 2 F	¥ 8,000
9 F × 9 F	¥ 7,000
6 F × 9 F	¥ 5,000
6 F × 6 F	¥ 4,000

Griffolyn

Size	RENTAL FEE
2 0 F × 2 0 F	¥ 8,000
2 0 F × 1 0 F	¥ 8,000
1 2 F × 1 2 F	¥ 4,000
9 F × 1 2 F	¥ 3,500
9 F × 9 F	¥ 3,000
6 F × 9 F	¥ 3,000
6 F × 6 F	¥ 2,000

Silver Lame

Size	RENTAL FEE
9 m × 1 2 m	¥ 24,000
2 0 F × 2 0 F	¥ 12,000
1 2 F × 1 2 F	¥ 8,000
9 F × 1 2 F	¥ 7,000
9 F × 9 F	¥ 6,000
6 F × 9 F	¥ 4,000
6 F × 6 F	¥ 3,000

Silver Griffolyn

Size	RENTAL FEE
2 0 F × 1 0 F	¥ 12,000
1 2 F × 1 2 F	¥ 8,000
9 F × 1 2 F	¥ 7,000
9 F × 9 F	¥ 6,000
6 F × 9 F	¥ 4,000
6 F × 6 F	¥ 3,000

Gold Lame

Size	RENTAL FEE
2 0 F × 2 0 F	¥ 12,000
1 2 F × 1 2 F	¥ 8,000
9 F × 1 2 F	¥ 7,000
9 F × 9 F	¥ 5,000
6 F × 9 F	¥ 4,000
6 F × 6 F	¥ 3,000

Cucoloris (White & Black)

Size	RENTAL FEE
1 2 F × 1 2 F White	¥ 15,000
1 2 F × 1 2 F Black	¥ 15,000

Blue / Green Sheet

Size	RENTAL FEE
2 0 F × 2 0 F	¥ 6,000
1 2 F × 1 2 F	¥ 4,000
9 F × 1 2 F	¥ 3,000
6 F × 9 F	¥ 2,000
6 F × 6 F	¥ 2,000

Camouflage Net

Size	RENTAL FEE
1 6 F × 1 6 F	¥ 6,000

Skyblue

Size	RENTAL FEE
1 3 m × 1 5 m	¥ 30,000
9 m × 1 2 m	¥ 20,000
2 0 F × 2 0 F	¥ 15,000
1 2 F × 1 2 F	¥ 8,000
9 F × 1 2 F	¥ 6,000
9 F × 9 F	¥ 5,000
6 F × 9 F	¥ 4,000
6 F × 6 F	¥ 3,000

Dayblue/Daygray

Size	RENTAL FEE
2 0 F × 2 0 F	¥ 15,000
2 0 F × 1 0 F	¥ 15,000
1 2 F × 1 2 F	¥ 8,000
9 F × 1 2 F	¥ 6,000
9 F × 9 F	¥ 5,000
6 F × 9 F	¥ 4,000
6 F × 6 F	¥ 3,000

Nightblue/Nightgray

Size	RENTAL FEE
2 0 F × 2 0 F	¥ 15,000
1 2 F × 1 2 F	¥ 8,000
9 F × 1 2 F	¥ 6,000
9 F × 9 F	¥ 5,000
6 F × 9 F	¥ 4,000
6 F × 6 F	¥ 3,000

※ Rental Fee doesn't include tax.

CLOTH

Chromakey Digital Green			
Size	RENTAL FEE		
1 0 m × 1 5 m	¥	80,000	
8 m × 1 0 m	¥	64,000	
6 m × 8 m	¥	48,000	
2 0 F × 2 0 F	¥	42,000	
1 2 F × 1 2 F	¥	24,000	
9 F × 1 2 F	¥	24,000	
9 F × 9 F	¥	23,000	
6 F × 9 F	¥	20,000	
6 F × 6 F	¥	12,000	

Chromakey Digital Green (Fireproof)			
Size	RENTAL FEE		
1 0 m × 1 5 m	¥	100,000	
8 m × 1 0 m	¥	83,000	
6 m × 8 m	¥	62,000	
2 0 F × 2 0 F	¥	50,000	
1 2 F × 1 2 F	¥	30,000	
9 F × 1 2 F	¥	30,000	
9 F × 9 F	¥	30,000	
6 F × 9 F	¥	26,000	
6 F × 6 F	¥	15,000	

Chromakey Digital Green MG (With Velcro) (Fireproof)			
Size	RENTAL FEE		
1 2 F × 1 2 F	¥	24,000	
9 F × 1 2 F	¥	24,000	
9 F × 9 F	¥	24,000	
6 F × 9 F	¥	20,000	
6 F × 6 F	¥	12,000	

Chromakey Green (Stretch Material)			
Size	RENTAL FEE		
8 m × 1 0 m	¥	64,000	
6 m × 8 m	¥	48,000	
2 0 F × 2 0 F	¥	42,000	
1 2 F × 1 2 F	¥	24,000	
6 F × 6 F	¥	12,000	

Chromakey Blue			
Size	RENTAL FEE		
1 0 m × 1 5 m	¥	80,000	
8 m × 1 0 m	¥	64,000	
6 m × 8 m	¥	48,000	
3 m × 4 m	¥	24,000	
2 0 F × 2 0 F	¥	42,000	
1 2 F × 1 2 F	¥	24,000	
9 F × 1 2 F	¥	24,000	
6 F × 6 F	¥	12,000	
9 F × 1 0 m	¥	60,000	
6 F × 1 0 m	¥	45,000	
3 F × 1 0 m	¥	30,000	

Chromakey Digital Blue (Fireproof)			
Size	RENTAL FEE		
1 0 m × 1 5 m	¥	100,000	
8 m × 1 0 m	¥	83,000	
6 m × 8 m	¥	62,000	
1 2 F × 1 2 F	¥	30,000	
9 F × 1 2 F	¥	30,000	
9 F × 9 F	¥	30,000	
6 F × 9 F	¥	26,000	
6 F × 6 F	¥	15,000	

Chromakey Digital Blue			
Size	RENTAL FEE		
1 0 m × 1 5 m	¥	80,000	
8 m × 1 0 m	¥	64,000	
2 0 F × 2 0 F	¥	42,000	
1 2 F × 1 2 F	¥	24,000	
9 F × 1 2 F	¥	24,000	
6 F × 9 F	¥	20,000	
6 F × 6 F	¥	12,000	

Chromakey Blue MG (With Velcro)			
Size	RENTAL FEE		
1 2 F × 1 2 F	¥	24,000	
9 F × 1 2 F	¥	24,000	
9 F × 9 F	¥	23,000	
6 F × 9 F	¥	20,000	
6 F × 6 F	¥	12,000	

Chromakey Blue (Stretch Material)			
Size	RENTAL FEE		
8 m × 1 0 m	¥	64,000	
2 0 F × 2 0 F	¥	42,000	
1 2 F × 1 2 F	¥	24,000	
9 F × 9 F	¥	18,000	
6 F × 6 F	¥	12,000	

GENERATOR TEST

Generator Output (A)				
Frequency	50Hz	60Hz	50Hz	60Hz
PF	60%	80%	60%	80%
	Single	Single	Parallel	Parallel
2.8k Generator	16.8A	22.4A	33.6A	44.8A
1.6k Generator	9.6A	12.8A	19.2A	25.6A
900w Generator	5.4A	7.2A	10.8A	14.4A

5.5k Generator	Voltage Switch		
	100V	100V/200V	
Voltage	100V only	100V only	200V only
output	under 5.5KVA	under 5.5KVA	under 5.5KVA
		100V and 200V concurrent	
		Total under 5.5KVA ※	

※The limit during operation at 100V is 2.75KVA.

★Precautions for use of Generators★

- Fuel is “Regular gasoline” only for all Generators. Please be careful not to put sand, dust or any other allotrio into fuel tank.
- Never refuel during operation.
- Please put Generators on level place.
- Please do not cover Generators with poly board, plywood, sheet during operation. It may cause overheat or any other troubles.
- Please do not move Generators during operation. It may cause engine stop. Especially during operation on camera car, sidling G-forces may cause engine stop.

[Precautions for using 900W / 1.6K Generators.]

- Before starting engine, please press the switch on the upper part of the filler cap to ON. If the engine does not start, please open filler cap and start it again. If Generator is tilted, engine cannot start. Engine stops if the Generator gets tilted during operation.
- When using 2 Generators in parallel, please connect parallel cables and match frequencies before turning them on. Please check that the pilot lamp is green. If pilot lamp is red, stop the engine, disconnect parallel cables and restart it.

[Precautions for using 2.8kw Generators]

- When using 2 Generators in parallel, please connect parallel cables and match frequencies before turning them on. Please check that the pilot lamp is green. If the pilot lamp is red, stop the engine, disconnect parallel cables and restart the engine with Eco throttle on. (Single running is needed because the microcomputer remembers parallel mode)
- Since the air inlet is located underneath Generator, please cover the ground with plywood or something else before starting engine for the use in the park or on the beach.

[Precautions for using 5.5kw Generators]

- Never change voltage or frequency during operation
- When using Generators for high output, Please turn off Eco Throttle to reduce the voltage variation.

FLICKER TEST

○ No Flicker
 △ Slight Flicker × Flicker

FLICKER TEST												
	AC Source						HMI Electrical Ballast (ARRI B&S)					
	50 Hz			60 Hz			Synchro mode		FF mode		300Hz mode	
	Shutter Angle	Pulse	Rating	Shutter Angle	Pulse	Rating	Shutter Angle	Rating	Shutter Angle	Rating	Shutter Angle	Rating
24fps	172.8	2	○	144	2	○	180	○	180/90	○	Please use Synchro mode or FF mode.	
25fps	180	2	○	150	2	○	180	○	180/90	○	Please use Synchro mode or FF mode.	
30fps	108	1	○	180	2	○	180/90	○	180/90	○	Please use Synchro mode or FF mode.	
45fps	162	1	○	135	1	○	×	×	180	○	180/90/45	○
50fps	180	1	○	150	1	○	×	×	180	○	180/90/45	○
60fps	108	0.5	△	180	1	○	180	△	180	○	180/90/45	○
75fps	135	0.5	△	112.5	0.5	△	×	×	180	○	180/90	○
90fps	162	0.5	△	135	0.5	△	×	×	180	○	180/90	○
100fps	180	0.5	○	150	0.5	△	×	×	180	○	180/90/45	○
120fps	×	×	×	180	0.5	○	180	△	180	○	180/90	○
150fps	×	×	×	×	×	×	×	×	180	△	180/90	○
240fps	×	×	×	×	×	×	×	×	OPEN	×	OPEN	○
300fps	×	×	×	×	×	×	×	×	OPEN	×	OPEN	○

※1 When using HMI Magretic Balast, please choose frames per second and shutter angle according to the formula. (Shutter angle = frames per second x 360 ÷ frequency)

※2 For shooting HS movie more than 60 frames per seconds with HMI Electrical Ballast (FF mode), we recommend 2.5kw fixture or more.

※3 When using ARRI SUN with HMI Electrical Ballast (FF mode), please focus the light on the object and shoot below 100frames per second.

※4 When using ARRI SUN with HMI Electrical Ballast (300Hz mode), please focus the light on the object and shoot below 150frames per second with shutter angle 180° .

※5 Please set the dimmer of the Ballast at maximum for High Speed Shooting.

KINO FLO FLICKER TEST

	50Hz						60Hz					
	180°		90°		45°		180°		90°		45°	
	100V	115V	100V	115V	100V	115V	100V	115V	100V	115V	100V	115V
24fps	○	○	○	○	×	×	○	○	○	○	○	○
30fps	○	○	○	○	△	△	○	○	○	○	△	○
48fps	○	○	×	×	×	×	○	○	×	×	×	×
60fps	○	○	×	×	×	×	○	○	○	○	×	×
72fps	×	×	×	×	×	×	○	○	×	×	×	×
90fps	×	×	×	×	×	×	×	×	×	×	×	×
100fps	○	○	△	△	△	△	×	×	×	×	×	×
120fps	×	×	×	×	×	×	○	○	×	×	×	×

○ No Flicker △ Slight Flicker × Flicker

Precautions for safety use!!

Fixture

- ① Please check electric Voltage (V) and Current (A).
- ② Please check the following points about the place to set the equipments.
 - Please check if there is a need of any protective items.
 - Please check about prevention against overturn.
 - Please check if there are sprinklers or fire alarm sensors above lighting fixtures.
 - Please check if there is something flammable above fixtures.
 - Please check if there is something flammable in front of fixtures.
- ③ Please use the cables which are long enough.
- ④ Please set the fixtures at the allowable angle.
- ⑤ Since fixtures generate harmful ultraviolet light, please don't remove back-cover or lens.
- ⑥ Hold a plug or a connector when unplugged.
- ⑦ Shutter and Scrim are not available for ARRI SUN.
- ⑧ Shutter is not available for ARRI-X.
- ⑨ Please do not attach paper or combustible tape on the fixtures.
- ⑩ Please set the lens outmost from bulb when you turn off the fixture.
(Please set diaphragm maximum.) Otherwise lens might be broken by temperature change.
- ⑪ Please read "Precautions" and "Warning about Ballast" on page 4.
- ⑫ Please ground to prevent electric shock caused by electric leak.



Stand

- ① Please check following points about the place to set the stands.
 - Please check if there is a need of any protective items.
 - Please check if there are prevention measures against overturn.
- ② Please check the load capacity of the stand.
- ③ Please do not extend the stand to the maximum.
(Please extend the stand about 10cm shorter than the maximum.)
- ④ Please do not move the stand as extended.
- ⑤ Please be careful about center of gravity when using with the booms.



Grip

- ① Please be careful not to tighten the grips too much.
- ② Please check if there is anything to be protected. When you hold the cloth such on pipes, please be sure to use any protective items to cover pipes.
- ③ Please check about load capacity of Hanger and Border ropes.
- ④ The devices to prevent the grips dropping are necessary when you work on high.
- ⑤ After using radios or meters please return them to the original position.
(* Many radio earphones have been missing. Please be sure to return all the equipments.)
- ⑥ When using cloth, please be careful not to make break or blot.
- ⑦ When you use cloths, please be careful not to break or stain.



ATTENTION

Precautions for safety use!!

Tower

- ① Please protect the place which you set up the towers on by using protective mats.
- ② Please check the level of the place before setting up towers.
- ③ Please wear helmet and safety belt when you set up towers and work on them.
- ④ When you put the equipments on the towers or put them down from the towers, please be sure to prevent dropping the equipments. Also please check no one is around the towers.
- ⑤ Working on the towers in rain is dangerous and towers are slippery. Please wear the appropriate footwear.



Cable - Power Source

- ① Please use the cables which have enough current-carrying capacity, and use the cables under their load capacity.
- ② Please check voltage (100v or 200v) before turning on. If you change the cable connection, please check voltage again before turning on.
- ③ “Electrical Worker License” is required to connect cables with the switchboard. Please contact the building manager before connecting.
- ④ Please ground to prevent the electric shock caused by electric leak. Please be sure to use “Earth Leakage Breaker” when you operate around a pool or in rain.
- ⑤ Please use the cable protectors. Never step on the cables by foot or vehicle. Cable crush or damage may cause overheat or burn.



Expendable

- ① Please use such as frame retardant tracing paper when you diffuse the top light. Never use the normal tracing paper.
- ② When you diffuse 3kw or 5kw Border Light, or 4kw Main Light, please use frame retardant tracing paper. Depending on the way to use, even the retardant paper might catch fire. Do not cover the fixture with tracing paper.
- ③ You have to buy the filters, tapes and other expendable which get wet with rain even if they are unused.
- ④ Please do not tape up the lighting fixtures. Tapes cannot be removed after turning off because of the heat. If you need to tape up the facilities themselves, please check the surface and see if you can tape them up. Some wallpaper could be torn off by tapes.
- ⑤ When you use the water protection filter, please do not let the filter touch the fixture. Otherwise the filter easily melts.



Battery Life Time

● 24v Battery (at 24v & 9A / at 12v & 38A) ● Dryfit Battery (11A)

※Notice: Battery life time depends on temperature and condition of Battery, Ballast, Lamp bulb.

HMI		ARRI 1.2kCP	ARRI 575wCP	POCKET PAR 400w	ARRI 200wCP	POCKET PAR 200w	POCKET PAR 200w	POCKET PAR 125w	HR-II 125w
		ARRI 575/1.2 DC Ballast	DC Ballast	ARRI 200/400 DC Ballast		ARRI 125/200 DC Ballast		HR-II DC Ballast	
Battery / Number		1. 2kw	575w	400w	200w		200w	125w	125w
24v Battery	4	30min	90min	140min	320min		-	-	-
	2	10min	30min	60min	165min		105min	235min	-
	1	-	-	-	-		50min	75min	120min
Dryfit Battery LB-24F(11A)	2	-	-	-	85min		60min	170min	-
	1	-	-	-	-		-	60min	75min
Dryfit Battery	2	-	-	30min	120min		130min	190min	-
	1	-	-	-	-		30min	75min	100min
Dryfit Battery LB-H4(16. 8A)	2	-	-	80min	180min		205min	290min	355min
	1(Use 1 Jack)	-	-	-	-		95min	155min	150min
	1(Use 2 Jack)	-	-	-	70min		35min	60min	55min

TUNGSTEN		CINE KING 600w	24v 200w FOCUSING LIGHT	24v 250w PULSAR
Battery / Unit				
24v Battery	1	40min	100min	100min
Dryfit Battery	1	—	60min	—

KINO FLO		40w8BANK	40w4BANK	40w2BANK	40w1BANK	20w4BANK	20w2BANK	20w1BANK	VistaBeam	DIYA400	DIYA200	12v Single Kit
Battery / Unit		1. 8k KINO FLO INVERTER										
24v Battery	4	90min	—	—	—	—	—	—	110min	340min	—	—
	2	40min	80min	—	—	120min	—	—	45min	140min	200min	—
	1	—	40min	100min	160min	60min	140min	230min	—	50min	90min	—
Dryfit Battery	1	—	20min	70min	130min	50min	120min	190min	—	—	—	330min

LED Battery	FL Location Kit	Sola4	Sola6	CELEB 200	CELEB 400	CELEB 401Q	SKYPANEL 300C	1x1 FELLONI	CINEROID 10	CINEROID 400
Associated Battery										
V-mount Battery								80min~180min		80min
Sony Battery									120min	
Dryfit Battery	630min	190min		120min	120min	60min (4500K* 100%)		LB-380:60min LB-H4:80min		
Cinekin Battery			140min			75min (4500K* 100%) (24V)				
power consumption				100w	210w	210w	420w	50w	18w	72w

LED Battery	DEDOLIGHT ZILLA	LITE PANEL KIT	Filfox P100	Filfox P360	ARRI L5-C	1x1 FLEX LIGHT	1x1 FLEX LIGHT BiColor
Associated Battery		40min					
V-mount Battery			130min	90min		120min	Daylight : 165min Tungsten : 150min
Sony Battery	300min						
Dryfit Battery				210min	120min (5500K* 100%) (24V)		
Cinekin Battery							
power consumption	8w		34w	40w	90w	115w	50w

LED Battery	ALADDIN Pocket Light	ALADDIN A Light	ICELIGHT	1 × 4 FlexBiColor	Fotodiox 1500	Fotodiox 300	Fotodiox 318
Associated Battery	90min	70min	210min			90min	90min
V-mount Battery				40min(DUO150)	90min		
Sony Battery							
Dryfut Battery				140min(LB-H4)			
Cinekin Battery							
Power Consumption	60w	8w		50w		30w	30w

Light Input Power (A)

	Name	Commercial power		Generator	
		100V	200V	100V	200V
1	18kw HMI(12/18 NewPS)		97A		97A
2	18kw HMI(12/18 PS)		97A		97A
3	12kw HMI(12/18 NewPS)		65A		65A
4	12kw HMI(12/18 PS)		65A		65A
5	12kw HMI(6/12 PS)		66A		66A
6	6kw HMI(6/12 PS)	69A	34.5A	69A	34.5A
7	4kw HMI(2.5/4 PS)	46.5A	23.2A	46.5A	23.2A
8	2.5kw HMI(2.5/4 PS)	29A	14.5A	29A	14.5A
9	1.2kw HMI(575w/1.2k NewPS)	13.5A	6.75A	13.5A	6.75A
10	1.2kw HMI(575w/1.2k PS)	13.9A	6.95A	13.9A	6.95A
11	575w HMI(575w/1.2k NewPS)	6.46A	3.23A	6.46A	3.23A
12	575w HMI(575w/1.2k PS)	6.7A	3.35A	6.7A	3.35A
13	575w HMI(400w/575w PS)	6.9A	3.45A	6.9A	3.45A
14	400w HMI(400w/575w PS)	4.8A	2.4A	4.8A	2.4A
15	200w HMI(125w/200w PS)	2.4A	1.2A	2.4A	1.2A
16	125w HMI(125w/200w PS)	1.5A	0.8A	1.5A	0.8A
17	5kHyper Blast		2.4A		2.4A
18	3kHyper Blast		1.4A		1.4A
19	Par Strobe	3.6A		3.6A	
20	3k Search Light(MAX)	50A	28A	50A	28A
21	2k Search Light(MAX)	36A	20A	36A	20A
22	2k Xenon Pin Spot(MAX)	36A	20A	36A	20A
24	Kinoflo40w8Bank	12A		12A	
25	Kinoflo40w4Bank	6A		6A	
26	Kinoflo40w2Bank	3.12A		3.12A	
27	Kinoflo40w1Bank	1.5A		1.5A	
28	Kinoflo20w4Bank	3A		3A	
29	Kinoflo20w2Bank	1.56A		1.56A	
30	Kinoflo20w1Bank	0.75A		0.75A	
31	Kinoflo110w4Bank	7.2A		7.2A	
32	Kinoflo110w2Bank	4.44A		4.44A	
33	Kinoflo110w1Bank	2.64A		2.64A	
34	Diva-Lite400w	2.28A	1.08A	2.28A	1.08A

Generator Output (A)						
	Name	50Hz	60Hz	50Hz	60Hz	
		PF 60%	PF 80%	PF 60%	PF 80%	
		Single	Single	Parallel	Parallel	
1	5. 5k Generator	/	45A	/	/	
2	2. 8k Generator	16.8A	22.4A	33.6A	44.8A	
3	1. 6k Generator	0.96A	12.8A	19.2A	25.6A	
4	900w Generator	0.54A	0.72A	10.8A	1.44A	

Generator Output (A)						
	Name	50Hz	60Hz			
		PF 60%	PF 80%			
1	75kVA Generator	500A	600A			
2	100kVA Generator	600A	800A			
3	150kVA Generator	900A	1.200A			
4	200kVA Generator	1.200A	1.600A			
5	250kVA Generator	1.500A	2.000A			
6	300kVA Generator	1.800A	2.400A			
7	500kVA Generator	3.000A	4.000A			

Light Input Power (A) & Generator						
	Name	Commercial Power		Generator		Instantaneous Input
		100V	200V	100V	200V	
1	Lightning Strikes 500kw	/	400A	/	3.600A	約2.100A
2	Lightning Strikes 250kw	/	200A	/	2.160A	約1.050A
3	Lightning Strikes 70kw	/	65A	/	400A	約300A
4	Lightning Strikes 40kw	/	40A	/	250A	約175A
5	Lightning Strikes 25kw	40A	/	150A	/	約210A

STAGE LIGHTING SYSTEM Fama

Fama,inc.
4-27-1,Fujimi-cho,Chofu-city
Tokyo 182-0033 Japan
TEL 81-(0)42-488-2611 FAX 81-(0)42-488-2612
E-mail fama@fa-ma.co.jp
<http://www.fa-ma.co.jp>

BMFL Spot



- Manufacturer : ROBE
- Lamp : 1700W
- Gobos : 12 rotating gobos
- Dual Graphic Wheel
- Color : CMY color mixing
: 12 fixed colors
- Zoom : 5~55°
- Frost : Light, Medium Frosts
- Input Power : 200V
- Wattage : 2000W (230V/50Hz)
- Weight : 36kg
- Dimension : W483 × D335
× H813 (mm)

MYTHOS



- Manufacturer : Clay Paky
- Lamp : 470W
- Zoom : [Spotlight mode] 4~50°
[Beam mode] 2.5°
- Gobos : 6 rotating gobos
18 fixed metal gobos
- Color : CMY color mixing
14 fixed colors
- Input Power : 100V or 200V
- Wattage : 700W (230V/50Hz)
- Weight : 31kg
- Dimension : W420 × D404 × H628
(mm)

VL3000spot



- Manufacturer : Philips Vari-Lite
- Lamp : 1200W
- Gobos : 14 rotating gobos
- Color : CMY color mixing
: 6 fixed colors
- Zoom : 10~60°
- Input Power : 200V
- Wattage : 1000W (200V/50Hz)
- Weight : 41kg
- Dimension : W508 × D457
× H802 (mm)

MAC Viper Performance



- Manufacturer : Martin
- Lamp : 1000W
- Gobos : 5 rotating gobos
- Color : CMY color mixing
7 fixed colors
- Animation wheel
- Frosted filter
- Zoom : 10~44°
- Input Power : 200V
- Wattage : 1200W (230V/50Hz)
- Weight : 37.1kg
- Dimension : W472 × D335
× H731 (mm)

MAC Aura



- Manufacturer : Martin
- Lamp : RGBW 4in1 LED
- Zoom : 11~58°
- Input Power : 100V or 200V
- Wattage : 260W (100V/50Hz)
- Weight : 5.6kg
- 寸法 / W302 × D220 × H332
(mm)

LED Quad Par



- Lamp : RGBW 4in1 LED
- Beam angle : 25°
- Input Power : 100V or 200V
- Wattage : 120W (100V/50Hz)
- Weight : 3kg
- Dimension : W255 × D255 × H350
(mm)



<http://www.arc-system.co.jp>

name

tel 81. (0) 42-480-5611 fax 81. (0) 42-480-5613